

↗ DOMETIC MOBILE COOLING CFF

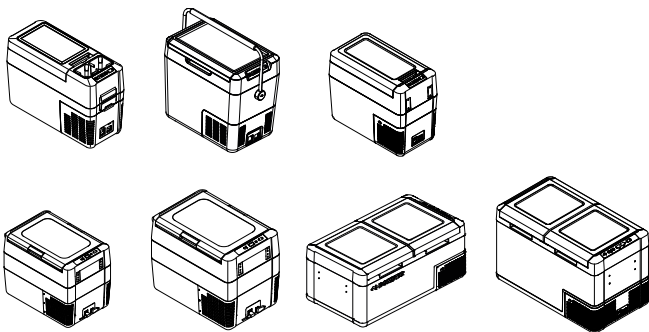

CFF12, CFF18, CFF20, CFF35, CFF45, CFF50LPDZ, CFF70DZ

EN

Portable fridge

Short Operating Manual.....

Copyright

© 2024 Dometic Group. The visual appearance of the contents of this manual is protected by copyright and design law. The underlying technical design and the products contained herein may be protected by design, patent or pending patent. The trademarks mentioned in this manual belong to Dometic Sweden AB. All rights are reserved.

English

1 Important notes

Please read these instructions carefully and follow all instructions, guidelines, and warnings included in this product manual in order to ensure that you install, use, and maintain the product properly at all times. These instructions **MUST** stay with this product.

By using the product, you hereby confirm that you have read all instructions, guidelines, and warnings carefully and that you understand and agree to abide by the terms and conditions as set forth herein. You agree to use this product only for the intended purpose and application and in accordance with the instructions, guidelines, and warnings as set forth in this product manual as well as in accordance with all applicable laws and regulations. A failure to read and follow the instructions and warnings set forth herein may result in an injury to yourself and others, damage to your product or damage to other property in the vicinity. This product manual, including the instructions, guidelines, and warnings, and related documentation, may be subject to changes and updates. For up-to-date product information, please visit documents.dometic.com.

2 Explanation of symbols on the device



Warning! Risk of fire. Flammable materials.

3 Related documents



Find the full operating manual online on qr.dometic.com/bfCyQu.

4 Safety instructions



DANGER! Electrocutation hazard

- > On boats: If the device is powered by the mains, ensure that the power supply has a residual current device (RCD), a residual current circuit breaker (RCCB), or a ground fault circuit interrupter (GFCI). Installation, especially in potentially damp areas, must be in accordance with all applicable installation regulations.
- > Do not touch exposed cables with your bare hands. This applies especially when operating the device from the AC mains.
- > Before starting the device, ensure that the power supply line and the plug are dry.



WARNING! Explosion hazard

Do not store any explosive substances such as spray cans with a flammable propellant in the cooling device.



WARNING! Electrocutation hazard

- > Do not operate the cooling device if it is visibly damaged.

- > If the cooling device's power cable is damaged, it must be replaced with a suitable power cable or assembly available from the manufacturer or its service agent to prevent safety hazard.
- > This cooling device may only be repaired by qualified personnel. Improper repairs can lead to considerable hazards.
- > Plug the device to sockets that ensure proper connection especially when the device needs to be earthed.



WARNING! Fire hazard

- > When positioning the cooling device, ensure that the supply cord is not trapped or damaged.
- > Do not locate multiple portable socket-outlets or portable power supplies at the rear of the device.
- > In the event of any damage to the refrigerant circuit:
 - Keep open flames and potential ignition sources away from the cooling device.
 - Ventilate the room well.
 - Switch off the cooling device.
- > For cooling devices with flammable refrigerant: The refrigeration circuit contains a small quantity of an environmentally friendly but flammable refrigerant. It does not damage the ozone layer and does not increase the greenhouse effect. Any leaking refrigerant may ignite.
- > Keep the ventilation openings on the device housing or in installations free of obstructions.
- > Do not use any mechanical objects or other means to speed up the defrosting process, unless they have been recommended by the manufacturer for this purpose.
- > Do not open or damage the refrigerant circuit.
- > Do not use electrical devices inside the cooling device unless they are recommended by the manufacturer for that purpose.



WARNING! Health hazard

- > This cooling device is not intended for use by persons (including children) with reduced physical, sensory or mental capabilities, or lack of experience and knowledge, unless they have been given supervision or instruction concerning use of the cooling device by a person responsible for their safety.
- > Children must be supervised to ensure that they do not play with the device.
- > Cleaning and user maintenance must not be carried out by unsupervised children.



CAUTION! Electrocutation hazard

- > Before starting the cooling device, ensure that the power supply line and the plug are dry.
- > Disconnect the cooling device from the power supply
 - Before each cleaning and maintenance
 - After every use



CAUTION! Health hazard

- > To avoid contamination of food, observe the following instructions:
 - Check if the cooling capacity of the cooling device is suitable for storing the food to be cooled.
 - Food may only be stored in its original packaging or in suitable containers.
 - Opening the cooling device for long periods of time can cause significant increase of the temperature in the compartments of the device.
 - Clean regularly surfaces that can come in contact with food and accessible drainage systems.
- > If the cooling device is left empty for long periods:

- Switch off the cooling device.
- Defrost the cooling device.
- Clean and dry the cooling device.
- Leave the lid open to prevent mold from developing within the cooling device.



NOTICE! Damage hazard

- > Check that the voltage specification on the data plate corresponds to that of the energy supply.
- > Only connect the cooling device as follows:
 - With the DC connection cable to a DC power supply in the vehicle
 - With the AC connection cable to an AC power supply
- > Never pull the plug out of the socket by the cable.
- > If the cooling device is connected to a DC outlet, disconnect the cooling device and other power consuming devices from the battery before connecting a quick charging device.
- > If the cooling device is connected to a DC outlet, disconnect the cooling device or switch it off when turning off the engine. Otherwise the battery may be discharged.
- > The cooling device is not suitable for transporting caustic materials or materials containing solvents.
- > The insulation of the cooling device contains flammable cyclopentane and requires special disposal procedures. Deliver the cooling device at the end of its life-cycle to an appropriate recycling center.
- > Do not place the cooling device near open flames or other heat sources (heaters, direct sunlight, gas ovens, etc.).
- > **Risk of overheating!** Ensure at all times that there is a minimum of 50 mm ventilation on all sides of the cooling device. Keep the ventilation area free of any objects that could obstruct the air flow to the cooling components. Do not use or store the cooling device in closed compartments or areas with none or minimal air flow.
- > Do not fill the inner container with ice or fluids.
- > Never immerse the cooling device in water.
- > Protect the cooling device and cables against heat and moisture.
- > The cooling device shall not to be exposed to rain.

5 Intended use

The cooling device is suitable for cooling food. The cooling device is also suitable for use on vehicles.

The cooling device is designed to be operated from a DC on-board power supply of a vehicle or boat, from a DC auxiliary battery or from an AC power supply.

The cooling device is suitable for camping or other similar recreational uses.

The cooling device is intended to be used in household and similar applications such as:

- Staff kitchen areas in shops, offices and other working environments
- Farm houses
- Clients in hotels, motels and other residential type environments
- Bed and breakfast type environments
- Catering and similar non-retail applications

This product is only suitable for the intended purpose and application in accordance with these instructions.

This manual provides information that is necessary for proper installation and/or operation of the product. Poor installation and/or improper operation or maintenance will result in unsatisfactory performance and a possible failure.

The manufacturer accepts no liability for any injury or damage to the product resulting from:

- Incorrect installation, assembly or connection, including excess voltage
- Incorrect maintenance or use of spare parts other than original spare parts provided by the manufacturer
- Alterations to the product without express permission from the manufacturer
- Use for purposes other than those described in this manual

Dometic reserves the right to change product appearance and product specifications.

6 Operation

6.1 Avoiding food waste

To avoid food waste, note the following

- > Keep temperature fluctuation as low as possible. Only open the cooling device as often and for as long as necessary. Store the foodstuff in such a way that the air can still circulate well.
- > Adjust the temperature to the quantity and type of the foodstuff.
- > Foodstuff can easily absorb or release odor or taste. Always store foodstuff covered or in closed containers/ bottles.

6.2 Saving energy

- > Choose a well ventilated location which is protected from direct sunlight.
- > Allow warm food to cool down first before placing it in the cooling device to keep cool.
- > Do not open the cooling device more often than necessary.
- > Do not leave the cooling device open for longer than necessary.
- > If the cooling device has a basket: For optimal energy consumption, position the basket according to its position on delivery.
- > On a regularly basis, ensure the lid seal still fits properly.
- > Avoid unnecessarily low temperatures.

6.3 Operating

Scope of delivery:

1

12/24 VDC

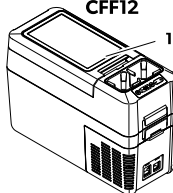
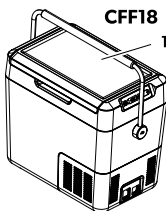
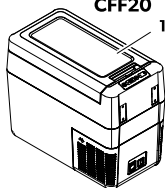
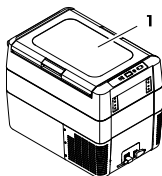
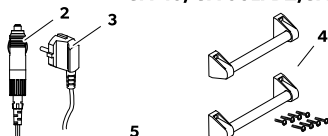
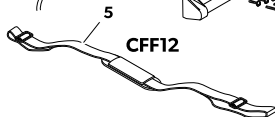
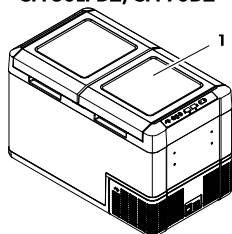

100-240 V AC

CFF12**CFF18****CFF20****CFF35, CFF45****CFF20, CFF35,
CFF45, CFF50LPDZ, CFF70DZ****CFF50LPDZ, CFF70DZ**

> Connect to a battery.

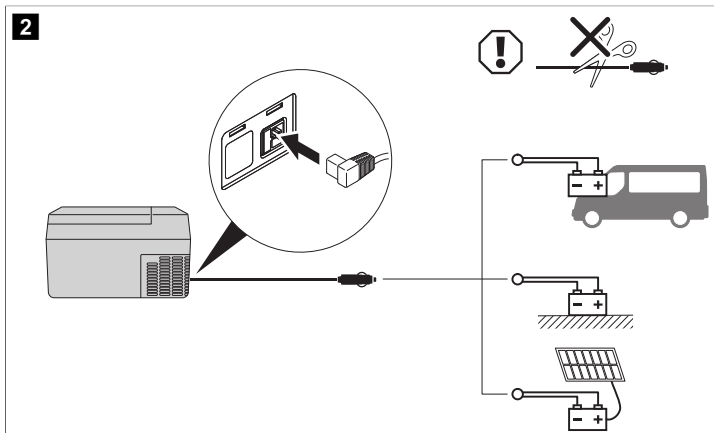

> Connect to an AC power supply.

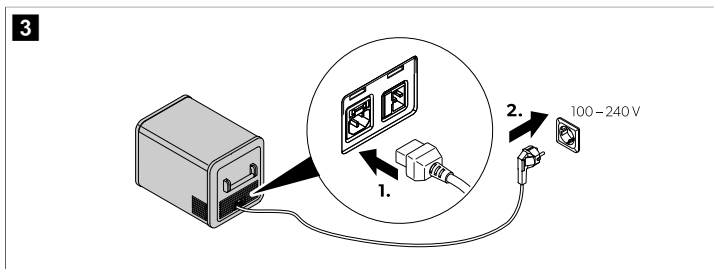

> Switch on.

4



CFF12

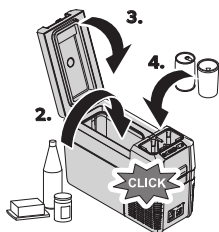

**CFF18, CFF20, CFF35,
CFF45, CFF50LPDZ, CFF70DZ**

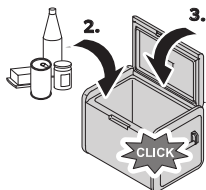

> Switch off and store.

5

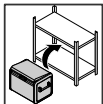

12/24 V
100-240 V

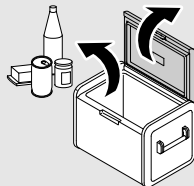

CFF35,
CFF45,
CFF50LPDZ,
CFF70DZ

CFF18

CFF35,
CFF45,
CFF50LPDZ,
CFF70DZ

CFF18

> Select the temperature unit.

6 CFF12, CFF18, CFF20, CFF35, CFF45

1.

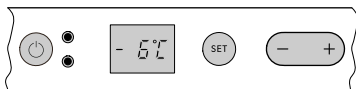

2.

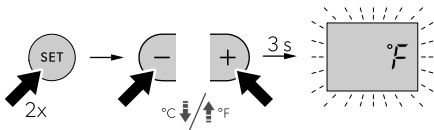

3.

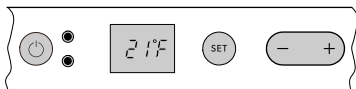

CFF50LPDZ, CFF70DZ

1.

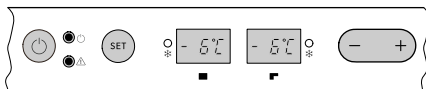

2.

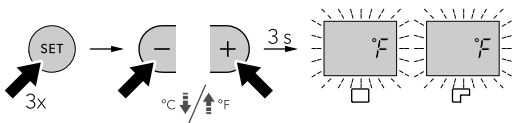

3.

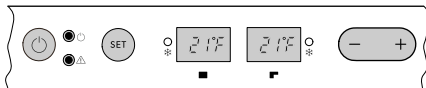

7

CFF12, CFF18, CFF20, CFF35, CFF45

1.

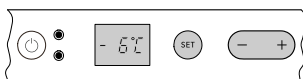

2.

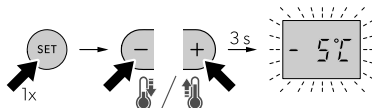

3.

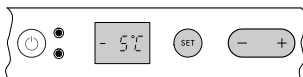

CFF50LPDZ, CFF70DZ

1.



2.

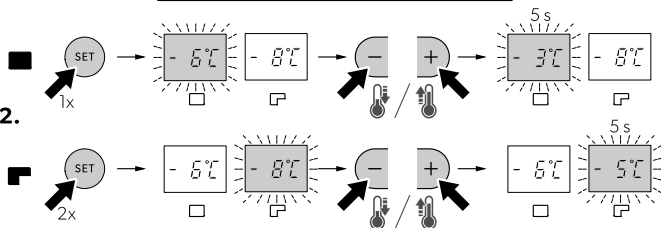

3.

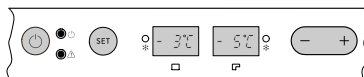

8

CFF12, CFF18, CFF20, CFF35, CFF45

1.

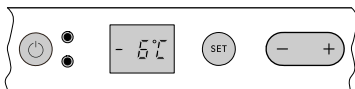

2.

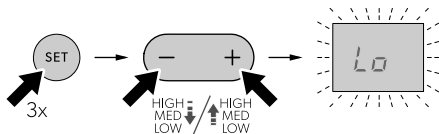

3.

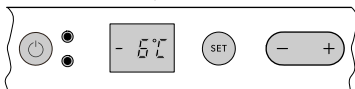

CFF50LPDZ, CFF70DZ

1.

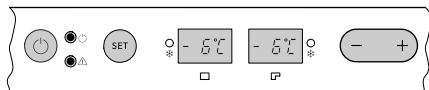

2.

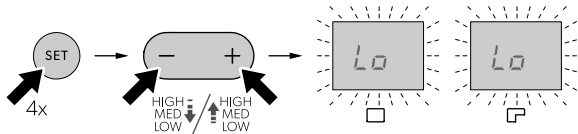

3.

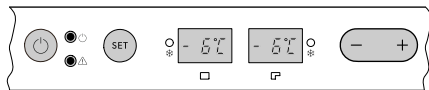

> Set the display's brightness.

9 CFF12, CFF18, CFF20, CFF35, CFF45

1.

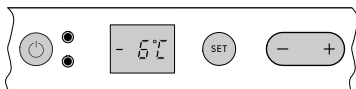

2.

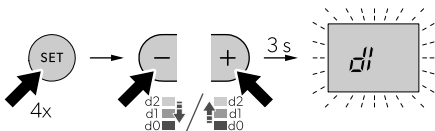

3.

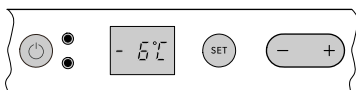

CFF50LPDZ, CFF70DZ

1.

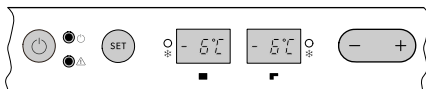

2.

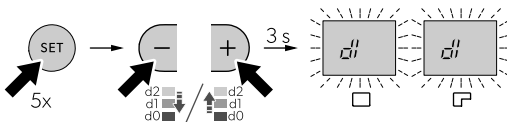

3.

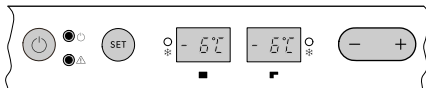

> Switch off the compartments (dual zone coolers).

10

CFF50LPDZ, CFF70DZ

1.

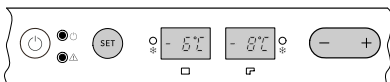

2.

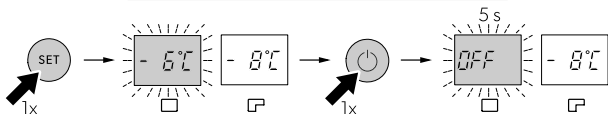

3.



1.

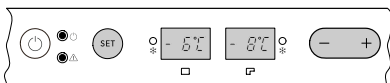

2.

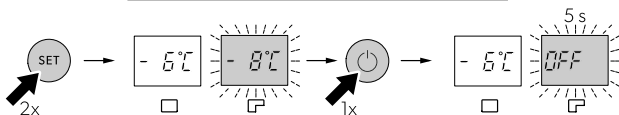

3.



> Switch on the compartments (dual zone coolers).

11

CFF50LPDZ, CFF70DZ

1.

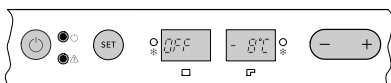

2.

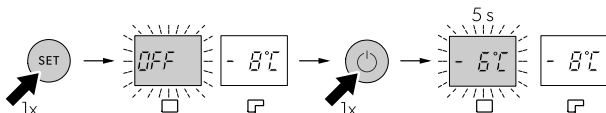

3.



1.



2.

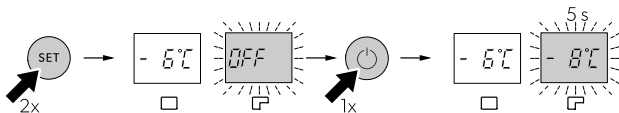

3.

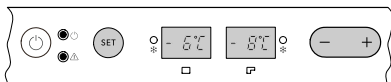

6.4 Battery monitor

The cooling device is equipped with a multi-level battery monitor that protects the vehicle battery against excessive discharging when the cooling device is connected to the on-board DC supply.





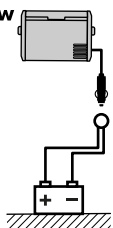

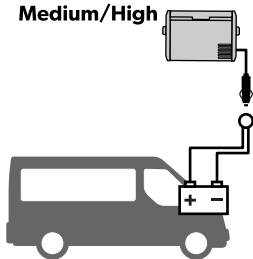

Low



Medium/High



| | | Low | Medium | High |
|--|---|--------|--------|--------|
| 12V  | OFF  | 10.1 V | 11.2 V | 11.8 V |
| | ON  | 11.4 V | 12.2 V | 12.6 V |
| 24V  | OFF  | 21.5 V | 24.1 V | 24.6 V |
| | ON  | 23.0 V | 25.3 V | 26.2 V |

7 Disposal



Recycling packaging material: Place the packaging material in the appropriate recycling waste bins wherever possible.



Recycling products with non-replaceable batteries, rechargeable batteries, or light sources:

- If the product contains any non-replaceable batteries, rechargeable batteries, or light sources, you don't have to remove them before disposal.
- If you wish to finally dispose of the product, ask your local recycling center or specialist dealer for details about how to do this in accordance with the applicable disposal regulations.



dometic.com

**YOUR LOCAL
DEALER**

dometic.com/dealer

**YOUR LOCAL
SUPPORT**

dometic.com/contact

**YOUR LOCAL
SALES OFFICE**

dometic.com/sales-offices
