

↗ DOMETIC MARINE CONTROL UNITS

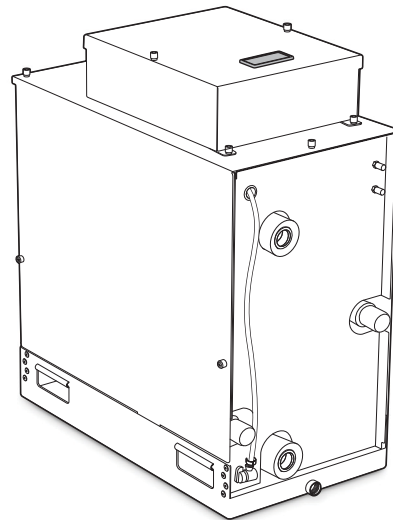
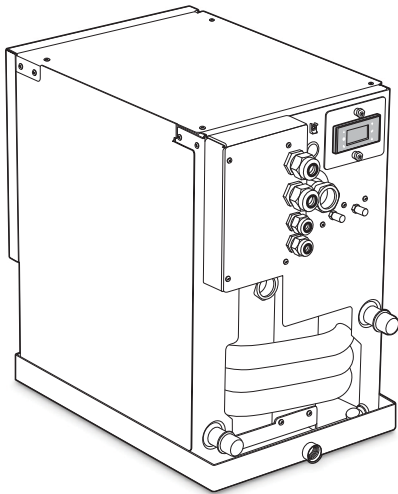

VARC MODELS

- EN VARC Chiller Controls**
Installation and Operation Instructions2

⚠ WARNING
Cancer and Reproductive Harm
www.P65Warnings.ca.gov

Service Center & Dealer Locations

Visit: www.dometic.com

Read these instructions carefully. These instructions **MUST** stay with this product.

Contents

1 Explanation of Symbols and Safety Instructions 2

1.1 Recognize Safety Information 2

1.2 Understand Signal Words 2

1.3 Supplemental Directives 3

1.4 General Safety Messages 3

2 General Information 3

2.1 Product Description 3

2.2 Inputs and Outputs 6

2.3 Default Parameters 8

3 Intended Use 12

4 Specifications 12

5 Installation and Setup 13

5.1 Initial Wiring 13

5.2 Multi-stage Wiring 14

5.3 Touch Screen Connection 15

5.4 Firmware Verification 15

5.5 Networking 16

5.6 Configuring Display Addresses 17

5.7 VARC Standard Wiring Diagram 18

6 Operation 19

6.1 Operational Modes 19

6.2 Powerup and Startup 21

6.3 Operating the Touch Screen 21

6.4 Operating the LCD Screen 25

7 Maintenance Mode 39

7.1 Accessing Maintenance Mode from the LCD Screen 39

7.2 Accessing Maintenance Mode from the Touch Screen 39

8 Troubleshooting 40

8.1 Alarms 40

8.2 Envelope Zone Status Descriptions 44

9 Disposal 44

10 Warranty Information 44

1 Explanation of Symbols and Safety Instructions

This manual has safety information and instructions to help you eliminate or reduce the risk of accidents and injuries.

1.1 Recognize Safety Information

 **This is the safety alert symbol.** It is used to alert you to potential physical injury hazards. Obey all safety messages that follow this symbol to avoid possible injury or death.

1.2 Understand Signal Words

A signal word will identify safety messages and property damage messages, and also will indicate the degree or level of hazard seriousness.

 **DANGER!**
Indicates a hazardous situation that, if **not** avoided, will result in death or serious injury.

 **WARNING**
Indicates a hazardous situation that, if **not** avoided, could result in death or serious injury.

 **CAUTION**
Indicates a hazardous situation that, if **not** avoided, could result in minor or moderate injury.

NOTICE: Used to address practices **not** related to physical injury.

 Indicates additional information that is not related to physical injury.

1.3 Supplemental Directives

To reduce the risk of accidents and injuries, please observe the following directives before proceeding to install or operate this appliance:

- Read and follow all safety information and instructions.
- Read and understand these instructions before installing or operating this product.
- The installation **must** comply with all applicable local or national codes, including the latest edition of the following standards:
 - American Coast Guard Standards (CG-ENG)
 - American Boat and Yacht Council (ABYC)
 - ANSI/NFPA70, National Electrical Code (NEC)

1.4 General Safety Messages

⚠ WARNING: ELECTRICAL SHOCK, FIRE, AND/OR EXPLOSION HAZARD. Failure to obey the following warnings could result in death or serious injury:

- Use only Dometic replacement parts and components that are specifically approved for use with the appliance.
- Avoid improper installation, adjustment, alterations, service, or maintenance of the appliance. Service and maintenance **must** be done by a qualified service person only.
- Do **not** modify this product in any way. Modification can be extremely hazardous.
- Use care when diagnosing and/or adjusting components on a powered unit.

2 General Information

The Dometic Variable Capacity Chiller (VARC) includes a microcontroller-based unit to control multiple chillers. The multiple-chiller design provides flexibility in the control application and improved controls and system protection.

i The images used in this document are for reference purposes only. Components and component locations may vary according to specific product models. Measurements may vary ± 0.38 in. (10 mm).

2.1 Product Description

This section describes some of the key design features of the VARC, the control application, the LCD and touch screen displays, and the inputs and outputs.

2.1.1 VARC Design Features

The VARC uses a precision Proportional Integral Derivative (PID) loop control algorithm that manages the capacity requirements of the system by modulating the compressor speed and balancing chiller output with the required load. The PID system differs greatly from the on/off control of a standard chiller system, as the PID modulates the speed of the compressor to increase or decrease its capacity allowing for reduced current consumption by the electrical system. This smooth operation eliminates large swings in current on the generator. This completely variable capacity chiller uses an inverter to modulate the speed of the compressor to achieve the desired chilled water setpoint. This allows the compressor to run at a minimum speed of 30 Hz to a maximum of 240 Hz depending on compressor model.

The VARC also uses the advanced technology of an Electronic Expansion Valve (EEV). This provides more precise control of superheat across a broad range of conditions with no erratic swings as the valve reacts to temperature and pressure changes (no “hunting”). Using an advanced algorithm, the VARC maintains superior superheat control over extreme operating conditions.

The VARC controller is internally grounded with isolation between inputs and outputs.

The output relays offer double isolation so that different voltages can be used for groups of relays.

For temperature measurements, the system uses NTC type 10K@77° thermistors.

For both suction and discharge monitoring, the system uses ratiometric 0–650 PSI (45 bar) range pressure transducers.

2.1.2 VARC Control Application

The built-in VARC control application supports the following features:

- Selection and sequencing of up to six chillers
- Selection and sequencing of one Chilled Water Pump (CWP) and one or more Sea Water Pumps (SWP)
- Selection and sequencing of up to six electric heaters
- Sequencing of devices for run time equalization
- Alarms and interlocks
- Load shedding
- Troubleshooting help

Sequencing for chillers, pumps, and heaters is the order in which they start up and turn off. Sequencing is based on run time, which is the amount of hours a specific compressor, pump, or heater has run.

The VARC is factory programmed with the options enabled for that system. Although the system offers flexibility, these options can be enabled only by a factory representative. Users can select Normal, Econo, or Boost mode operation in a single-stage configuration.

2.1.3 PGD1 LCD Display

The PGD1 provides an LCD display and six buttons for navigating the control software.

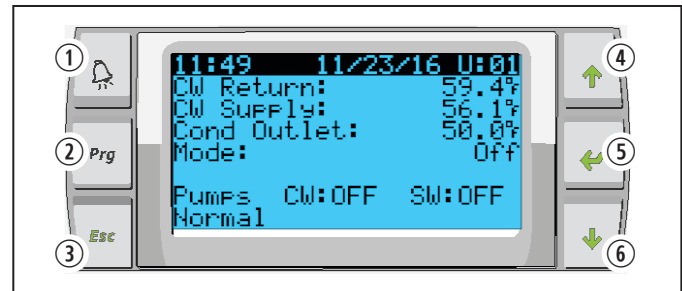

1 PGD1 LCD Display Components

- | | |
|-----------|---------------|
| ① Alarm | ④ Scroll Up |
| ② Program | ⑤ Enter |
| ③ Escape | ⑥ Scroll Down |

2.1.4 PLDPRO LCD Display

The PLDPRO provides an LCD display and six buttons for navigating the control software.

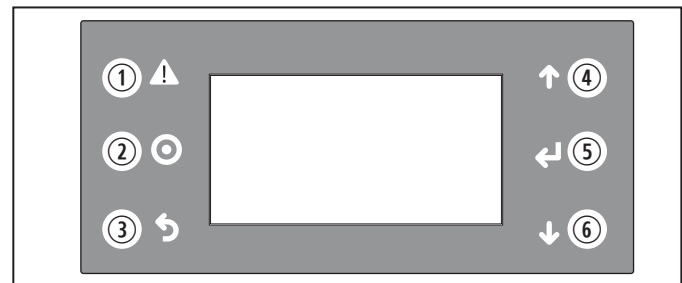

2 PLDPRO LCD Display Components

- | | |
|-----------|---------------|
| ① Alarm | ④ Scroll Up |
| ② Program | ⑤ Enter |
| ③ Escape | ⑥ Scroll Down |

2.1.5 LCD Buttons

The buttons on the PGD1 and PLDPRO operate as described in the following table:

Button	Description
Alarm	This button flashes red if there is an active alarm. Pressing this button displays the active alarm screen. See "Viewing Alarms for Each Stage" on page 28.
Program	This button displays the system menus. Use the scroll buttons to step through the options. Press the Enter button to select an option.
Escape	This button exits the current screen and displays the previous screen. Pressing this button multiple times displays the Main screen.
Scroll Up and Scroll Down	These buttons step through available menu options, change values in fields such as setpoints, and navigate from page to page when the flashing cursor is in the upper-left corner.
Enter	This button confirms menu option selections. Pressing Enter repeatedly moves the cursor the upper-left corner.

2.1.6 Touch Screen

This section describes the navigation buttons on the Main screen.

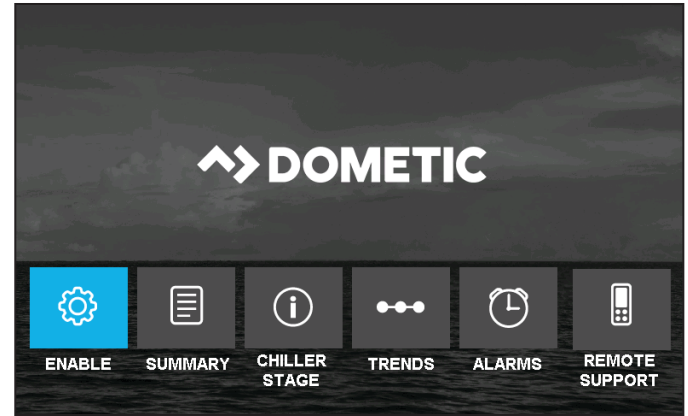

3 Touch Screen: Main Screen with Navigation Buttons.

The navigation buttons function as follows:

- **Enable:** Enter setpoints, monitor chilled water temperatures and monitor pump current information.
- **Summary:** View the state of HP, EH, FS, and water temperature for all available stages. Tapping a stage displays additional information on that stage.
- **Chiller Stage:** Monitors the refrigerant and chilled water circuits. Provides hotspot icons that display additional information when selected. Different icons appear depending which options are installed. The Forward and Back buttons navigate between stages.
- **Trends:** View a graphical display of water temperature, water pressure, and compressor current. Data is downloadable to a USB memory stick.
- **Alarms:** View and clear alarms. Pressing the buttons at the top-right displays alarm history and other alarm information.
- **Remote Support:** Enable third-party technical support to view your system over an Internet connection using a VNC (Virtual Network Computing) server.

2.2 Inputs and Outputs

The VARC allows you to monitor analog inputs, digital inputs, and relay outputs to determine the status of the system.

2.2.1 Analog Inputs

 If a temperature sensor is defective or not connected, the VARC generates an alarm for that sensor.

Input	I/O #	Board I/O	Description
Chilled Water Return Temperature Sensor	AI-1	B1	<p>The chilled water supply sensor is continuously monitored whether in Cooling, Reverse Cycle, or Electric Heat mode. It detects a high-temperature condition in the supply water from the chiller. If the chilled water temperature is greater than or equal to 125 °F (52 °C), the following occurs:</p> <ul style="list-style-type: none"> • In Reverse Cycle mode, all enabled compressor relays are de-energized, turning off the compressors. • In Electric Heating mode, all enabled heater relays are de-energized, turning off the heating elements. • A high temperature fault is generated. • The compressor or electric heat relay re-energizes when the temperature drops to 110 °F (43 °C). <p>You must acknowledge and clear the fault prior to re-enabling the VARC or the disabled stage. See “Viewing Alarms for Each Stage” on page 28.</p>
Freeze Temperature Setpoint	AI-2	B2	<p>The chilled water supply sensor is continuously monitored whether in Cooling, Reverse Cycle, or Electric Heat mode. It detects a freeze condition in the supply water of the chiller. If the chilled water temperature is equal to or less than 36 °F (2 °C), the following occurs:</p> <ul style="list-style-type: none"> • The compressor relay is de-energized, shutting off the compressor. • A low temperature fault is generated. • The compressor relay re-energizes when the temperature reaches 42 °F (6 °C). <p>You must acknowledge and clear the fault prior to re-enabling the VARC or the disabled stage. See “Viewing Alarms for Each Stage” on page 28.</p>
Condenser Freeze Protection	AI-3	B3	<p>The condenser outlet refrigerant temperature sensor monitors the condenser coil temperature. In Heat mode, if the coil temperature drops below 30 °F (-1 °C), the VARC automatically lowers the speed of the compressor to half the speed that it was currently running. While performing this operation, the display indicates Freeze Defrost.</p>
Suction Pressure ¹	AI-6	B6	<p>The VARC continuously monitors the suction pressure. If the suction pressure is below the alarm setpoint for longer than the programmed time delay, a Low Suction Pressure fault is generated.</p> <p>You must acknowledge and clear the fault prior to re-enabling the VARC or the disabled stage. See “Viewing Alarms for Each Stage” on page 28.</p>
Discharge Pressure ¹	AI-7	B7	<p>The VARC continuously monitors the discharge pressure. If the discharge pressure is above the alarm setpoint for longer than the programmed time, a High Discharge Pressure fault is generated.</p> <p>You must acknowledge and clear the fault prior to re-enabling the VARC or the disabled stage. See “Viewing Alarms for Each Stage” on page 28.</p>
Pump Current Monitoring (Optional) ¹	AI-9 (CW) AI-10 (SW)	B-9 (CW) B-10 (SW)	<p>Pump current monitoring for the chilled water and Sea Water Pump (SWP) is an optional feature. It requires the medium-sized PLC, instead of the standard smaller version. With this option, you can view the current draw from each pump on the PGD1 display and the touch screen.</p>

¹ The VARC has a proprietary algorithm that keeps the system from turning off immediately for low pressure or high pressure. The VARC gradually reduces its speed to compensate for low or high pressure conditions.

2.2.2 Digital Inputs

Digital inputs are used to monitor the status of the VARC protection circuits. At powerup, all discrete inputs are checked before the system is enabled. Any faults detected on startup must be verified and cleared via the VARC before the system will start normal operation. For information on clearing alarms, see “Viewing Alarms for Each Stage” on page 28.

Input	I/O #	Board I/O	Description
Refrigerant High Side Pressure Limit	DI-1	DI-1	If the high pressure switch is tripped and turns off the compressor, the VARC acknowledges an open circuit and generates a High Discharge Pressure fault. The VARC will not allow the compressor relay to be re-energized until the high pressure switch is in the closed position. You must acknowledge and clear the fault prior to re-enabling the VARC or the disabled stage. See “Viewing Alarms for Each Stage” on page 28.
Econo Mode Selection	DI-2	DI-2	This optional input is used to put the VARC into Econo mode. While Econo mode is enabled by this input, the VARC cannot be put into Normal or Boost mode.
Chilled Water Flow Switch	DI-3	DI-3	With the VARC in either Heat or Cool mode, the Flow switch must be closed prior to system starting or a stage being enabled. In operation, if flow is lost for more than 10 consecutive seconds, the following occurs: <ul style="list-style-type: none"> • The compressor or heat relay is disabled for the stage that has lost flow. • A Chilled Water Flow fault is generated. • The VARC goes into lockout. • A manual restart is required, after the system initiates, retries, and fails or exceeds timeout. You must acknowledge and clear the fault prior to re-enabling the VARC or the disabled stage. See “Viewing Alarms for Each Stage” on page 28.
Load Shedding Input	DI-4	DI-4	The load shedding standard input is activated with a 230 V signal. When load shedding becomes active, the VARC shuts off the compressor and maintains that state until the load shedding input is disabled. In a multi-stage operation, load shedding shuts down the stage with the highest run hours. Every unit has a load shed input. The number of load shedding signals received (one per unit) determines how many units are shut off according to run hours.
Electric Heat (E. H.) Flow Switch	DI-5	DI-5	This optional switch is enabled through the factory settings. With the VARC in either Heat or Cool mode, the Flow switch must be closed prior to system starting or a stage being enabled. In operation, if flow is lost for more than 10 consecutive seconds, the following occurs: <ul style="list-style-type: none"> • The electric heat is disabled for the stage that has lost flow. • An Electric Heat Flow fault is generated. • The VARC goes into lockout. • A manual restart is required, after the system initiates, retries, and fails or exceeds timeout. You must acknowledge and clear the fault prior to re-enabling the VARC or the disabled stage. See “Viewing Alarms for Each Stage” on page 28.
Cool Mode Selection Switch	DI-6	DI-6	These switches allow for remote mode control. When using digital input mode selection, the display cannot be used to change mode, but all other functions on the display are available.
Heat Mode Selection Switches	DI-7	DI-7	

2.2.3 Digital Relay Outputs

 If a temperature sensor is defective or not connected, the VARC generates an alarm for that sensor.

Output	I/O #	Board I/O	Description
SWP	DO-1	NO1	Provides switched power to the contactor coils for the Sea Water Pump.
CWP	DO-2	NO2	Provides switched power to the contactor coils for the Chilled Water Pump.
Reversing Valve (RV)	DO-3	NO3	Provides switched power to the coils for the Reversing Valve.

Output	I/O #	Board I/O	Description
Electric Heat (EH)	DO-4	NO4	Provides switched power to the contactor coils for electric heat.
Not used.	DO-5	NO5	This output is not used.
Not used.	DO-6	NO6	This output is not used.
Fault Alarm	DO-7	NO7/NC7	Provides a Normally Open (NO) contact point, which is closed for any fault condition. You can use this output to power a light, relay, or interface to a ship's monitoring system. The output on this terminal is 230 VAC.

2.2.4 Analog Outputs

The analog outputs are not used.

Output	I/O #	Board I/O	Description
Not used	AO-1	Y1	This output is not used.
Not used	AO-2	Y2	This output is not used.
Not used	AO-3	Y3	This output is not used.

2.3 Default Parameters

The following table lists factory defaults for the compressor, inverter, and econo mode setpoint parameters (for other VARC models, contact the factory).

Model	Compressor	Inverter Part Number
VARCX48	5KD184XAB21	PSD1* 12 Amp
VARCX60	TNB306FPGMT	PSD1* 12 Amp
VARCX72	5JD420XAA22	PSD1* 16 Amp
VARCX120		
208–230V / 1PH	SIAM ANB66FVCMT	PSD2* 30 Amp 200V
208–230V / 3PH	SIAM ANB66FVCMT	PSD2* 40 Amp 200V
380–460V / 3PH	SIAM ANB66FVQMT	PSD1* 40 Amp 400V

The following table lists factory defaults for all other parameters (for other VARC models, contact the factory).

Parameter	VARCX48	VARCX60	VARCX72	VARCX120	Data Type
General Settings					
Cooling Setpoint CCW Return	48	48	48	48	Degrees F
Cooling Setpoint CCW Supply	43	43	43	43	Degrees F
Heating Setpoint	110	110	110	110	Degrees F
Econo Mode	65%	65%	65%	65%	Percent
Superheat Setpoint					
Cool and Heat	10	10	10	10	Degrees F

Parameter	VARCX48	VARCX60	VARCX72	VARCX120	Data Type
Factory Settings					
Control Temp Mode	CCW Supply	CCW Supply	CCW Supply	CCW Supply	
Number of Stages	1	1	1	1	
Electric Heat	No	No	No	No	
Power Cycle	Retain Mode	Retain Mode	Retain Mode	Retain Mode	
Logo	Dometic BLK	Dometic BLK	Dometic BLK	Dometic BLK	
Background	Ocean	Ocean	Ocean	Ocean	
Flow Switch	Yes	Yes	Yes	Yes	
High Pressure Switch	Yes	Yes	Yes	Yes	
Low Pressure Switch	No	No	No	No	
EH Flow Switch	No	No	No	No	
Load Shedding	Yes	Yes	Yes	Yes	
SW Temp Inlet	Yes	Yes	Yes	Yes	
Sea Water Pump Settings					
Control	By Demand	By Demand	By Demand	By Demand	
Off Delay	5	5	5	5	Seconds
Pump Current	No	No	No	No	
Current Selection	10	10	10	10	Amps
Pump Control	Master	Master	Master	Master	
Chilled Water Pump Settings					
Control	Continuous	Continuous	Continuous	Continuous	
Flow Prove Delay	10	10	10	10	Seconds
Off Delay	5	5	5	5	Seconds
Pump Current	No	No	No	No	
Current Selection	10	10	10	10	Amps
Reversing Valve					
RV Delay On Time	45	45	45	45	Seconds
Electric Heat					
Stage Up Delay	60	60	60	60	Seconds
Stage Down Delay	20	20	20	20	Seconds
Compressor					
Min On Time	60	60	60	60	Seconds
Min Off Time	10	10	10	10	Seconds
Min Time between Starts	60	60	60	60	Seconds
Load Up Time	10	10	10	10	Seconds
Force Rotation	12	12	12	12	Hours
Load Up Stg Delay	60	60	60	60	Seconds
Avg Supply Delay	240	240	240	240	Seconds

Parameter	VARCX48	VARCX60	VARCX72	VARCX120	Data Type
Condenser Frost Protection					
Cond Setpoint	30	30	30	30	Degrees F
Cond Band	2.5	2.5	2.5	2.5	Degrees F
Comp Speed	60	40	40	40	RPS
Compressor PID					
Cntrl	P	P	P	P	
K	50	50	50	50	
Chilled Water High Temperature Limit Alarm					
Setpoint	125	125	125	125	Degrees F
Off Band (SP-)	15	15	15	15	Degrees F
Retries	6	6	6	6	
Retry Timeout	30	30	30	30	Minutes
Retry Delay	120	120	120	120	Seconds
Chilled Water Freeze Limit Alarm					
Setpoint	36	36	36	36	Degrees F
Off Band (SP+)	5.4	5.4	5.4	5.4	Degrees F
Retries	6	6	6	6	
Retry Timeout	10	10	10	10	Minutes
Retry Delay	120	120	120	120	Seconds
Chilled Water Flow Alarm					
Retries	6	6	6	6	
Retry Timeout	10	10	10	10	Minutes
Retry Delay	120	120	120	120	Seconds
High Discharge Pressure Alarm					
Retries	6	6	6	6	
Retry Timeout	30	30	30	30	Minutes
Retry Delay	120	120	120	120	Seconds
High Pressure Switch Alarm					
Retry	6	6	6	6	
Retry Timeout	30	30	30	30	Minutes
Retry Delay	120	120	120	120	Seconds
Low Suction Alarm					
Low Suction Pressure	60	60	60	60	PSI
Delay	180	180	180	180	Seconds
Retries	6	6	6	6	
Retry Timeout	30	30	30	30	Minutes
Retry Delay	120	120	120	120	Seconds

Parameter	VARCX48	VARCX60	VARCX72	VARCX120	Data Type
Inverter Alarm					
Retry	15	15	15	15	
Retry Timeout	60	60	60	60	Minutes
Retry Delay	300	300	300	300	Seconds
Configuration Menu					
Temperature Units	Degrees F	Degrees F	Degrees F	Degrees F	
Pressure Units	PSI	PSI	PSI	PSI	

3 Intended Use

The VARC Chiller Control is a chiller control application that supports touch screen and LCD interfaces.

This manual provides all necessary information for proper operation of the VARC Chiller Control application.

NOTICE: Poor setup and misunderstood operating parameters could result in unsatisfactory performance and possibly failure.

The manufacturer accepts no liability for damage in the following cases:

- Faulty assembly or connection
- Damage to the product resulting from mechanical influences and excess voltage
- Alterations to the product without express permission from the manufacturer
- Use for purposes other than those described in the operating manual

Dometic Corporation reserves the right to modify appearances and specifications without notice.

4 Specifications

The following table lists electrical specifications, environmental specifications, and touch screen dimensions, and setpoint ranges.

Electrical	
Line Voltage	See Data Label
Frequency	
Phase	
Chilled Water Pump Output	
Sea Water Pump Output	
Maximum Circuit Breaker Size ¹	

Environmental	
Maximum Ambient Operating Temperature	140 °F (60 °C)

Touch Screen Dimensions	
Height	5.79 in. (147 mm)
Width	7.36 in. (187 mm)
Depth	1.77 in. (45 mm)

¹ Increase breaker size to include pump current if running pumps directly from the system.

Setpoint Ranges ¹		
	Supply Control	Return Control
Cooling	42 °F (6 °C) to 55 °F (13 °C)	48 °F (9 °C) to 55 °F (13 °C)
Heating	95 °F (35 °C) to 115 °F (46 °C)	95 °F (35 °C) to 120 °F (49 °C)

¹ You cannot enter setpoint values outside of these ranges.

5 Installation and Setup

The VARC can be installed as a stand-alone chiller or as part of a staged system. The factory default setting is as a stand-alone chiller.

Installation for a staged system requires the following steps:

1. Make the connections between each stage of the chilled water and sea water.
2. Make the network connections between each stage (physical and network addressing).
3. Check the firmware version.
4. Configure the remote control panel.

Chillers supplied on a frame package are configured and wired as part of the build process.

i As part of a correctly configured multi-stage system there is no need to set differential/hysteresis settings.

5.1 Initial Wiring

⚠ WARNING: ELECTRICAL SHOCK HAZARD.

Exercise extreme care when working around energized equipment. Failure to obey this warning could result in death or serious injury.

1. Wire the sea water and chilled water pumps to VARC 1 (no need for pump relays) as follows:
 - a. Remove the power cover.
 - b. Connect the pumps to the terminals on the front of chiller 1, according to labeled connections.

Note: Daisy chaining outputs is not recommended if the units have individual power sources. Verify the phase of power before daisy chaining the outputs.

2. Wire the network connections from the network connection ports (VARC 1 to VARC 2, VARC 2 to VARC 3, and so forth).

Refer to the “Multi-stage Wiring” on page 14 for more information on wiring the stages.

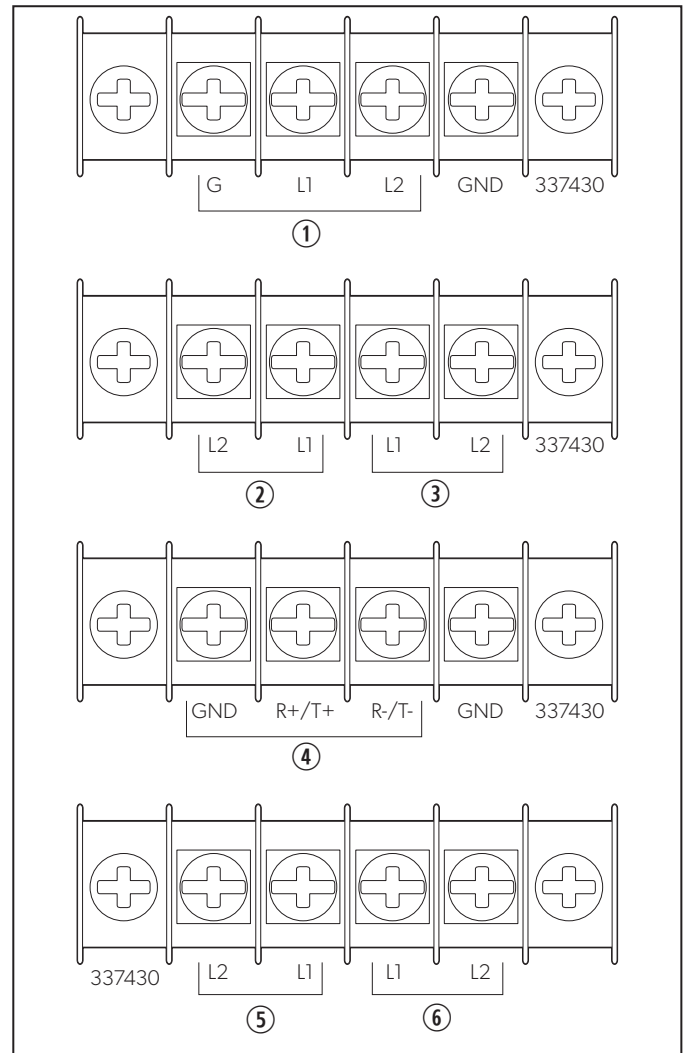

4 Electrical Connections VARC 48

- | | |
|-----------------------|---------------------------------------|
| ① Power Input | ④ Network Connection and Touch Screen |
| ② SW Pump (10 A max.) | ⑤ Load Shed Switch |
| ③ CW Pump (10 A max.) | ⑥ Elec. Heat Output |

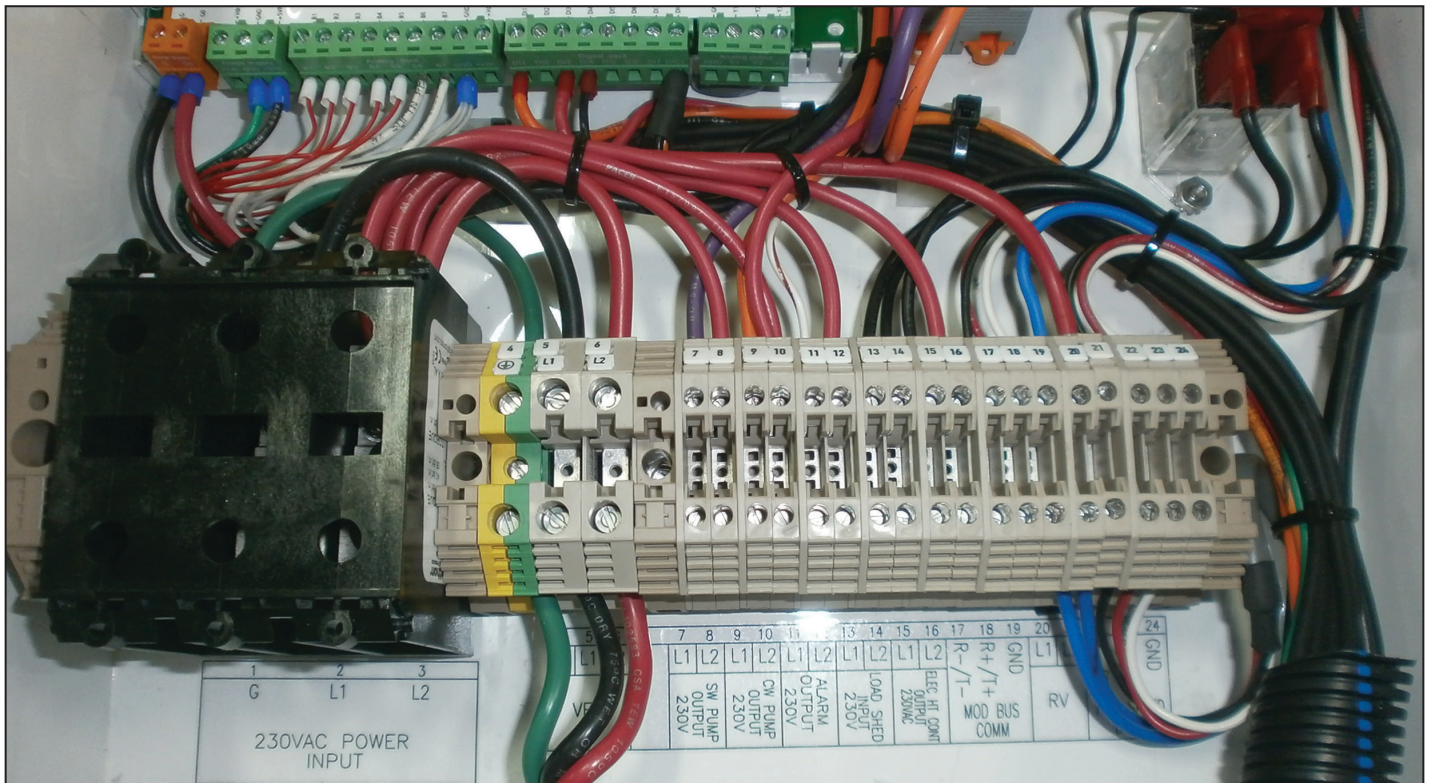

5 Electrical Connections VARC 60/72

5.2 Multi-stage Wiring

The following diagram shows how to wire multiple VARC stages.

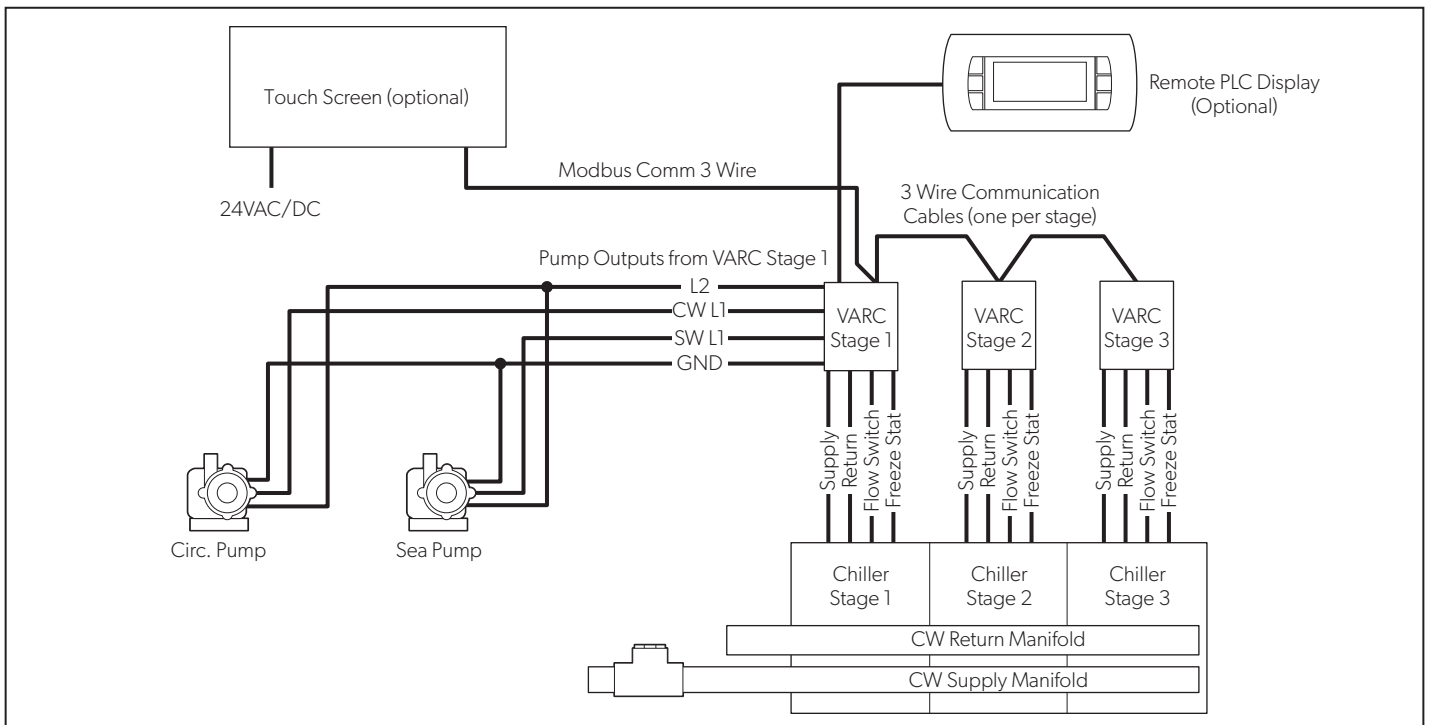

6 Multi-Stage Wiring Diagram

⚠ WARNING: ELECTRICAL SHOCK HAZARD.

Verify that all units' power lines are in unison phasing, in order to eliminate the potential for a short circuit. Failure to obey this warning could result in death or serious injury.

5.3 Touch Screen Connection

Make the following connections to the touch screen:

- a. A 24 VDC supply to power the display
- b. A three-core communication cable connected to serial port 1, not port 2

Terminate the three-core communication cable on Terminal Bus 3 (Modbus Com) on VARC 1.

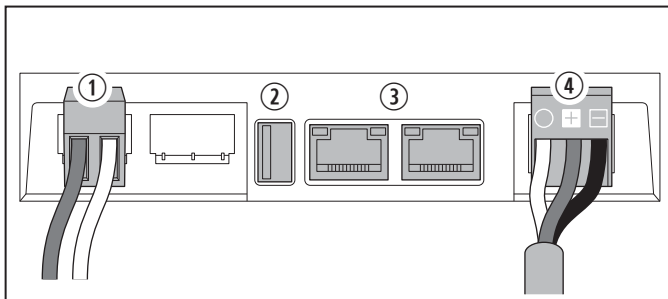

7 Touch Screen Connections

- ① Power Input (24 V)
- ② USB Port
- ③ Connection Port for Remote Connectivity
- ④ Communication Connection from PICO (3 Conductor, 18 G wire)

5.4 Firmware Verification

Chillers should come from the factory with the correct firmware preloaded. However, it is worth checking that the firmware versions of all chiller stages match, as incompatible firmware can seem to work during initial setup but then cause networking problems later.

To view the firmware version of a stage:

1. Press the Program button. See "LCD Buttons" on page 5.

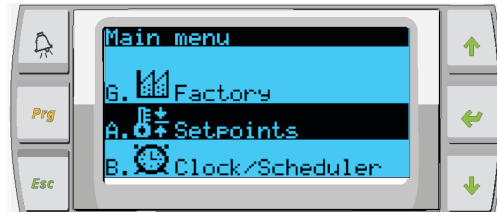

2. Scroll up or down to Technician, and then press Enter. If prompted for a password, enter 3156.

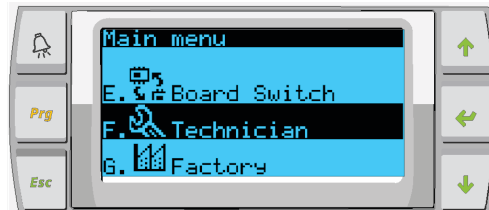

3. Select Information.

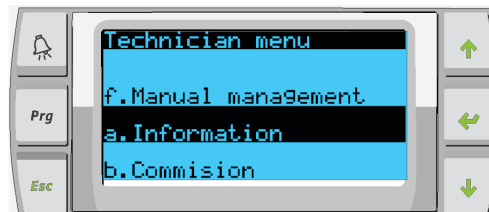

The Information screen is displayed.

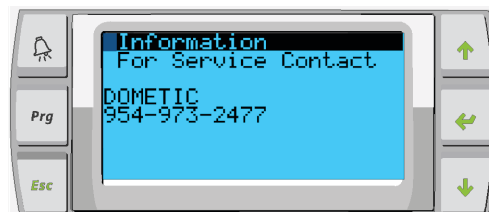

4. Scroll down to view version information.

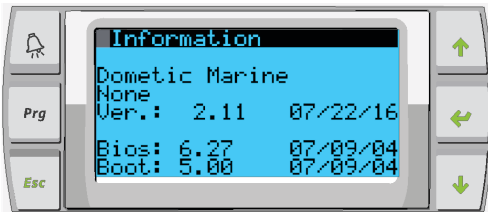

5. For Service Password, enter 3156.



5. Repeat for each stage.

Verify that all stages have the same version number. In the unlikely event that there is a difference between stages, the PCB firmware must be updated by a Dometic-approved technician.

6. Go to Stage Address.



5.5 Networking

When setting up the stages for networking, ensure that the chillers are not connected via Modbus connections. Stage 1 requires minimal changes, so start with stage 2, leaving stage 1 until last.

7. Press Enter, then change address to 2 for chiller 2, 3 for chiller 3, and so forth.

To set up networking, follow these steps:

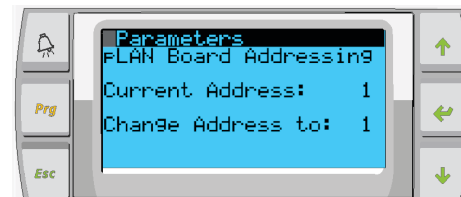

1. Power off all stages except stage 2.
2. Press the Program button. See "LCD Buttons" on page 5.
3. Go to Technician.

8. Press the Scroll Down button to display the next screen and change the number of stages. Press Enter until the cursor is on Num of Stages, then change from 1 to the correct number of stages for the current system.

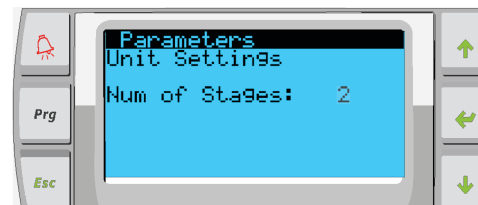

4. Scroll down to Service settings, then press Enter.

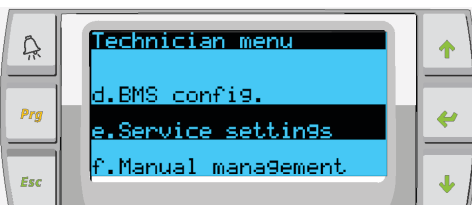

9. Repeat steps 2-8 for additional stages.
10. For stage 1, only perform step 8 to change the total number of stages.

5.6 Configuring Display Addresses

1. Display the configuration screen:
 - a. **PGDI:** Press and hold the Up, Enter, and Down buttons simultaneously for 6 seconds.
 - b. **PLDPRO:** Press and hold the Up, Down, and Program Mode buttons simultaneously for 6 seconds.

To locate buttons, see “LCD Buttons” on page 5.
2. Press Enter to access the Display address setting, and then scroll up or down to reach the address of the display per stage:
 - a. Stage 1: 16
 - b. Stage 2: 17
 - c. Stage 3: 18
 - d. Stage 4: 19
 - e. Stage 5: 20
 - f. Stage 6: 21



The message “Display address has been changed” appears, and then the display goes blank.

3. Repeat the three-button push from step 1 to enter the configuration.
4. Press Enter three times or until you reach the next screen.
5. Press Enter to go to the next screen.

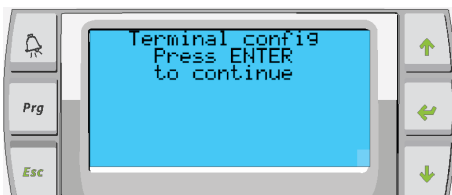

6. Follow these steps to select the address for Trm1 & 2 and select if it is private or shared:
 - a. Press enter once to enter the address of Trm1, and then scroll up or down to select the appropriate address (for addresses, see step 2).
 - b. Press Enter.
 - The cursor under Priv/Shared begins flashing.
 - Scroll up or down to select Pr, then press Enter. The cursor is next to Trm2.
 - Scroll up or down to select 32, then press Enter.
 - Scroll up or down to select Sh, then press Enter.
 - Press Enter two more times. The cursor is next to Ok?No.
 - Scroll to select Yes, then press Enter.

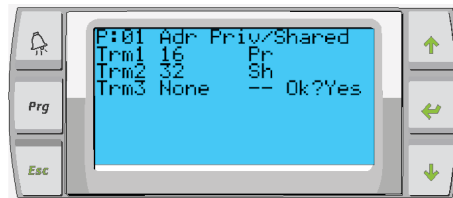

7. Connect all stages together with the network cable.

The data for all of the stages appears on the main screen.
8. If using a single common display or remote display, it must be configured as address 32.

5.7 VARC Standard Wiring Diagram

The following diagrams show the component connections for the standard VARC 48 and VARC 72. The VARC 60 is not shown.

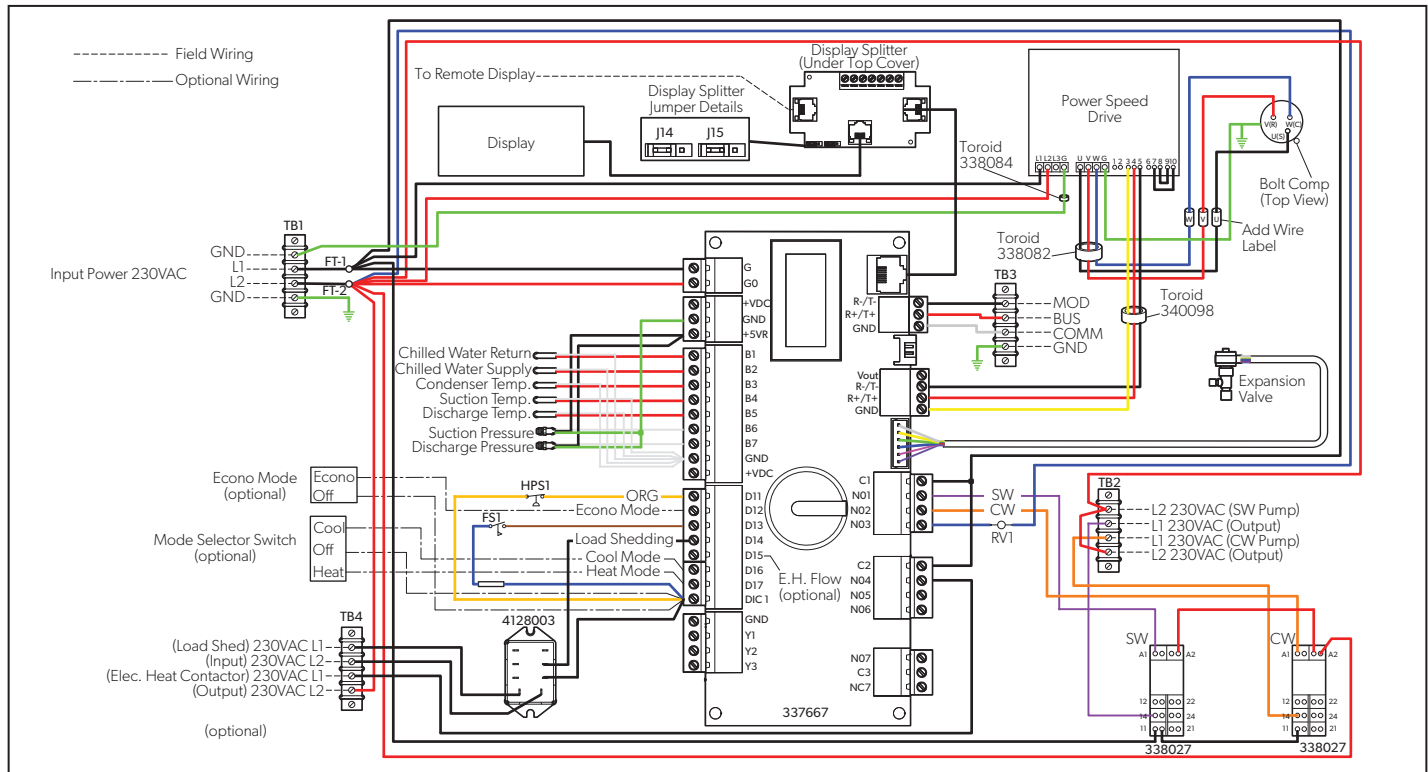

8 Wiring Diagram VARC 48

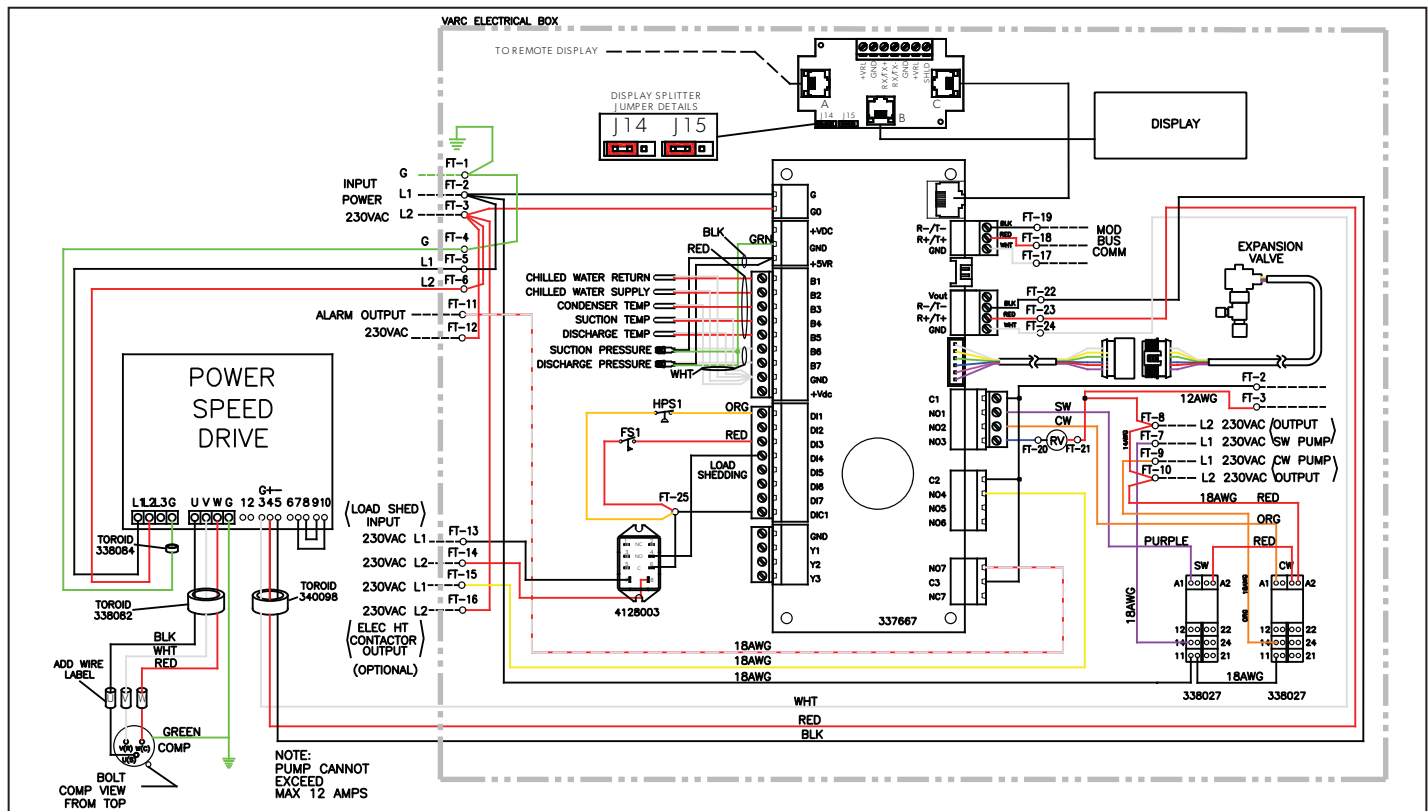

9 Wiring Diagram VARC 72

6 Operation

The VARC provides many operational features to conserve energy, improve performance, and provide system control.

6.1 Operational Modes

The main operational modes determine whether the VARC generates heat or cooling: Cool mode, Heat mode, and Electric Heat mode. Pump operation is coordinated with these modes.

The VARC also has Econo mode and a Maintenance mode for troubleshooting.

The operational modes can also be selected using the digital inputs if wired to the control board. These inputs allow you to select Econo mode if enabled for either cool or heat mode. Cool and Reverse cycle Heat mode can be selected by using the digital input controls. This allows the system to be switched between modes by using a common switch or controlled through some other automated system. These inputs do not support Electric heat operation.

6.1.1 Cooling and Heating

The VARC supports a Cool mode and two heating modes: Heat (reverse cycle heating) and Electric Heat.

Cool

When Cool is selected on the touch screen or the LCD buttons, the VARC starts cooling according to the temperature setpoint. The pumps operate as described in "Pump Operation" on page 20.

Cool mode activity is as follows:

- If the return water/supply water temperature is above the cooling setpoint and the staging delay has elapsed, the board energizes the compressor relay.
- The compressor continues to run until the cooling setpoint has been reached or an alarm condition exists.

- A stage has a minimum run time of 60 seconds before it can be turned off and a minimum off time of 10 seconds before it can be re-enabled. This minimum on time is required to ensure that the system is not cycling on and off and thereby not allowing the compressor to properly warm-up. This ensures proper oil lubrication of the system.
- If the system calls for a stage to be toggled on or off, the next available stage that meets the staging criteria is used.
- Load shedding occurs in multi-stage operation when approaching the chilled water setpoint.

Compressor rotation is active during run mode:

- The compressor with the lowest running hours is enabled first, and the compressor with the highest running hours is disabled first.
- After chilled water and sea water flows are stable for 10 seconds (default), the first stage is enabled, and the compressor starts.
- The first stage continues to run up to 100 percent speed before enabling the next stage.
- If the PID loop requires demand, then the next stage is enabled with a startup delay of three minutes before running up to required speed.

Heat (Reverse Cycle Heating)

When Heat is selected on the touch screen or the LCD buttons, the VARC starts heating according to the temperature setpoint. The pumps operate as described in "Pump Operation" on page 20.

Heat mode activity is as follows:

- There is a 45-second delay after the compressor ramps up before it is energized.
- The reversing valve relay is energized to operate the VARC in Reverse Cycle Heat mode.
- If the return/supply water temperature is below the programmed heating setpoint and the staging delay has elapsed, the VARC energizes the compressor relay.
- The compressor continues to run and the reversing valve remains energized until the heating setpoint has been reached or an alarm condition exists.

- If setpoint is reached, the compressor reduces its speed to maintain the water temperature. Once it has reached temperature and a hysteresis of one degree, the compressor turns off and the reversing valve turns off immediately.
- A stage has a minimum run time of 60 seconds before it can be turned off and a minimum off time of 10 seconds before it can be re-enabled. If the system calls for a stage to be toggled on or off, the next available stage that meets the staging criteria is used.

Compressor rotation is active during run mode:

- The compressor with the lowest running hours is enabled first and compressor with the highest running hours is disabled first.
- Enable Reverse Cycle Heat only for the system.
- After chilled water and sea water flows are stable for 10 seconds (default), the first stage is enabled and the compressor starts.
- The first stage continues to run up to 100 percent speed before enabling the next stage.
- If the PID loop requires demand, the next stage is enabled with a startup delay of three minutes before running up to the required speed.

Electric Heat (Optional Heater Barrel)

When Electric Heat is selected on the touch screen or LCD buttons, the VARC starts heating according to the temperature setpoint.

The VARC energizes the heater relay if return/supply water temperature is below the programmed setpoint and the staging delay has elapsed in a multi-stage configuration.

Heater rotation is active during run mode:

- The heater with the lowest running hours is enabled first and the heater with the highest running hours is disabled first.
- Enable Electric Heat only for the system.
- After chilled water flow is stable for 10 seconds, the first stage is enabled and the electric heater starts.
- The first stage continues to run for five minutes before enabling the next stage.
- If the PID loop requires demand, the next stage is enabled.

6.1.2 Pump Operation

The pump modes adjust as required by the system operating mode.

Chilled Water Pump

The chilled water pump relay closes if the system is in Heat or Cool mode. The pump is enabled five seconds prior to the first stage being enabled. The pump is on for continuous operation when system is enabled.

Sea Water Pump

The sea water pump has selectable operating modes between continuous operation or cycle-with-compressor operation. The default configuration is to cycle with the demand.

The sea water pump relay closes five seconds before the compressor starts in Heat or Cool modes. It opens five seconds after the last compressor cycle is completed. If immersion heating is available and used, the sea water pump is disabled.

6.1.3 Current Power Limiting

The Econo Mode provides control over the capacity of the system. When the user enables econo mode, the system is limited by the speed of the compressor.

The default value for econo mode is 65%. Under setpoints, the user can adjust the Econo Mode value between 35% and 90%.

6.1.4 Maintenance

Maintenance mode is available for troubleshooting. See “Maintenance Mode” on page 39.

6.2 Powerup and Startup

The VARC Chiller Controller can be operated as a single-stage or a multi-stage chiller plant. During initial setup, you configure the system for the number of stages and the available options. The VARC System is set for supply water control, but it can be modified for return water control, if needed.

6.2.1 Normal Stage Startup

The system has a time delay between the staging up of the various stages:

1. Stage 1 is initiated and starts its operation.
2. When the PID determines that more capacity is required, stage 2 is initiated.
3. When the system has maintained the chilled water loop and the PID has determined that no additional stage is required or has met capacity demand, it reduces the speed of the compressors.
4. The compressors then operate at minimal speed to maintain the chilled water loop. If the speed of the compressor still exceeds the demand, the stage with the most run hours is turned off.

6.2.2 Operational Checks

When the VARC is enabled, the system performs pre-startup checks on all chilled water flow switches and HP switches.

Individual stage faults disable only that stage.

6.2.3 Compressor Startup

The VARC utilizes a BLDC compressor that is capable of operating at a very high frequency which requires that the compressor have a ramped startup to establish proper lubrication so as to not damage the compressor. This startup has a ramp time and a minimal speed operation that will last for 100 seconds to allow the compressor to properly warm up before operating at maximum speed.

The compressor minimum on time is 60 seconds and minimum off time is 10 seconds with a minimum time between starts of 60 seconds. These default parameters allow the compressor to operate in a safe mode that will not damage the compressor.

6.3 Operating the Touch Screen

 Some screens contain pop-up screens with information. To exit a pop-up, simply touch the X to close the screen.

6.3.1 Basic VARC Operations

From the Chiller Enable screen, you can perform the basic VARC operations:

- Change setpoints
- Select Cool, Heat, or Electric Heat
- Monitor water temperature and pump status
- Turn the VARC off

To display the Chiller Enable screen, from the Main screen, tap Chiller Enable. See “Touch Screen” on page 5.

Figure 10 shows the controls on the Chiller Enable screen.

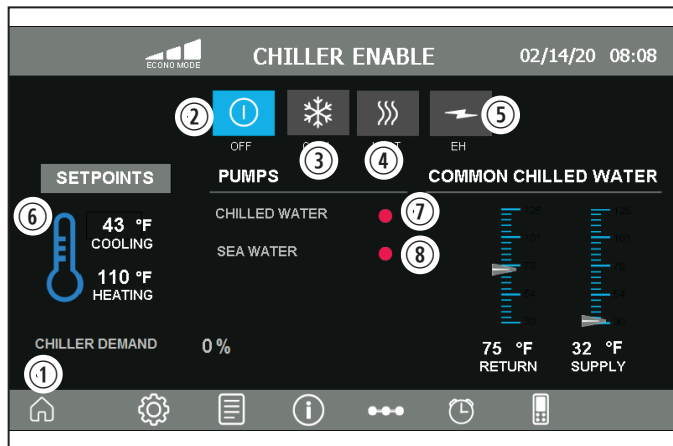

10 Chiller Enable Screen

- ① Home
- ② Power Button
- ③ Cool Button
- ④ Heat Button
- ⑤ Electric Heat Button
- ⑥ Setpoints
- ⑦ Chilled Water Pump
- ⑧ Sea Water Pump
- ⑨ Econo Mode Button

- **Home:** Displays the Main screen.
- **Power Button:** Turns the VARC off. When the VARC is in a run state, this button is green.
- **Cool Button:** Lights up with the word COOL when the VARC is cooling. Tapping this button puts the VARC into cool mode.
- **Heat Button:** Lights up with the word HEAT when the VARC is heating. Tapping this button puts the VARC into heat mode.
- **Electric Heat Button:** Lights up with the words ELECTRIC HEAT when electric heat is enabled. Tapping this button puts the VARC into Electric Heat mode. This button is visible only if the electric heat option is installed.
- **Setpoints:** Displays the current setpoints for cooling and heating. Tapping the numbers changes the setpoints.

- **Chilled Water Pump and Sea Water Pump:** Tapping this area takes you to the Pump Status screen.
- **Econo Mode Button:** Tapping this button displays the Econo Mode screen, which allows you to select Normal or Econo Mode.

6.3.2 Selecting Econo Mode

1. From the Main screen, tap Chiller Enable. See “Touch Screen” on page 5.
2. In the top-left corner of the Chiller Enable screen, click the Econo Mode button.

The Econo Mode screen appears.

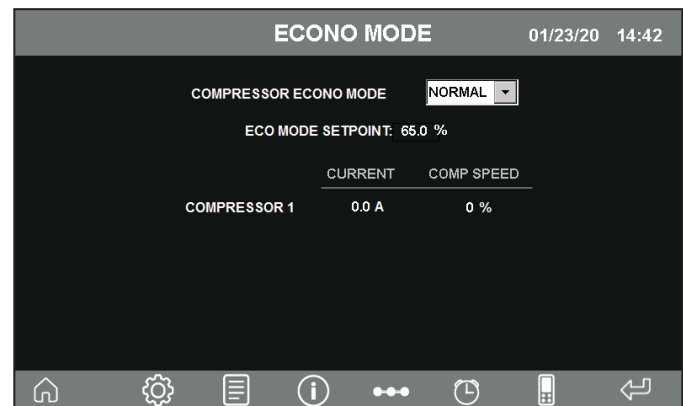

11 Econo Mode Screen

3. Select the desired mode from the Compressor Current Mode menu.
4. Select the Eco Mode Setpoint value to change the value of the econo mode.
5. To return to the Chiller Enable screen, in the top-left corner, tap the left-arrow button.

6.3.3 Viewing Chiller Status for Each Stage

The Chiller Summary screen provides chiller status for all stages. It also indicates if a stage is in Alarm Retry mode.

1. To display the Chiller Summary screen, from the Main screen, tap Chiller Summary. See “Touch Screen” on page 5.
2. To display a stage, tap its VARC number.

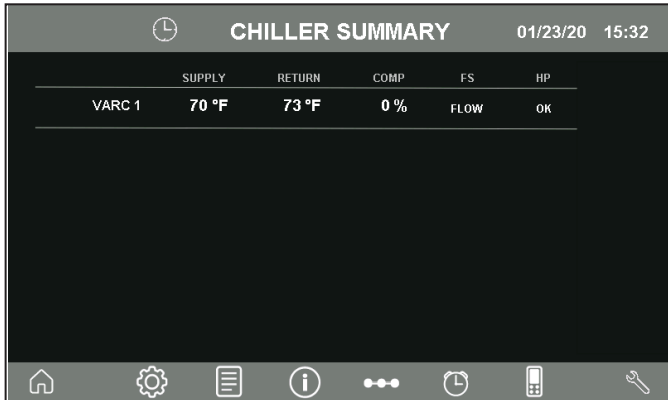

12 Chiller Summary

6.3.4 Monitoring Refrigerant and Chilled Water Circuits

The Chiller Stage screen provides a graphic representation of the refrigerant and chilled water circuits.

To display the Chiller Stage screen, from the Main screen, tap Chiller Stage. See “Touch Screen” on page 5.

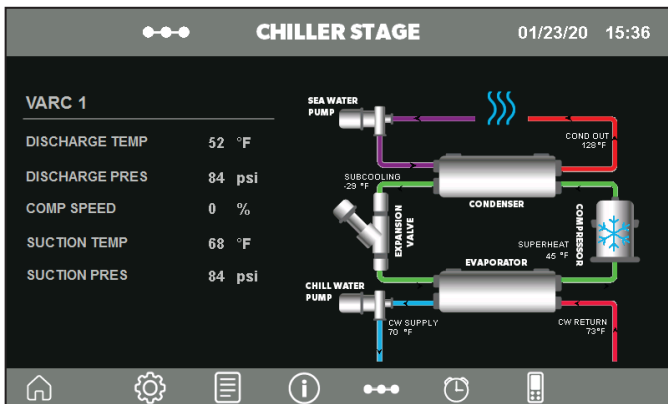

13 Chiller Stage Screen

i Depending on installed options, different icons appear as hotspots for navigation to open another window. When the system is in run mode, additional icons appear to indicate cooling and heating.

Using the Electronic Expansion Valve (EEV), you can monitor the following parameters:

- a. Valve position
- b. Suction pressure and temperature
- c. Superheat setpoint and actual value

To view EEV parameters, on the Chiller Stage Screen, tap the Expansion Valve icon.

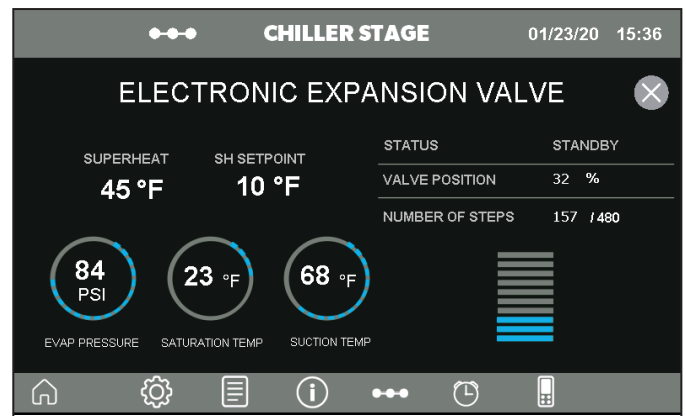

14 Expansion Valve Screen

6.3.5 Viewing and Downloading Performance Data

The Trends screen provides graphical representation of the VARC performance data.

1. To display the Trends screen, from the Main screen, tap Trends. See “Touch Screen” on page 5.
2. To change the time frame, select a time from the menu. The default is one month.

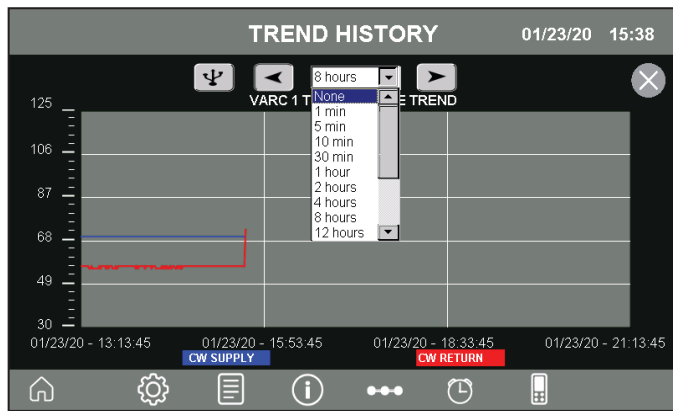

15 Chiller Trends Screen

3. To download performance data, insert a USB drive into the USB port on the VARC, and then tap the USB button.

i If you do not put the USB drive in first, you get the message shown in Figure “16 USB Message” on page 24.



16 USB Message

6.3.6 Viewing Active Alarms and Downloading Alarm History

The Alarms screen shows all active alarms and allows you to view the alarm history.

1. To display the Alarm screen, from the Main screen, tap Alarms. See “Touch Screen” on page 5.
2. To reset alarms, press the RESET ALARMS button.
3. To display the alarm history, tap the History button.

NAME	DESCRIPTION
1 Chilled Water Flow	Check VARC #1
1 High Pressure Switch	Check VARC #1

17 Active Alarm Screen

4. To change the time frame, select a time from the menu.

Name	Time	Description
3 Limp Mode	1/23/2020 2:42:00 PM	Check VARC #3
4 Limp Mode	1/23/2020 2:42:00 PM	Check VARC #4
1 Limp Mode	1/23/2020 2:42:00 PM	Check VARC #1
1 Limp Mode	1/23/2020 10:22:46 ...	Check VARC #1
3 Limp Mode	1/23/2020 10:22:46 ...	Check VARC #3
4 Limp Mode	1/23/2020 10:22:46 ...	Check VARC #4
4 Limp Mode	1/22/2020 8:12:41 AM	Check VARC #4
1 Limp Mode	1/22/2020 8:12:41 AM	Check VARC #1
3 Limp Mode	1/22/2020 8:12:41 AM	Check VARC #3

18 Alarm History Screen

5. To download alarm history, insert a USB drive into the USB port on the VARC, then tap the USB button.

1 Limp Mode	1/23/2020 2:42:00 PM	Che
1 Limp Mode	1/23/2020 10:22:46 ...	Che
3 Limp Mode	1/23/2020 10:22:46 ...	Che
4 Limp Mode	1/23/2020 10:22:46 ...	Che
4 Limp Mode	1/22/2020 8:12:41 AM	Che
1 Limp Mode	1/22/2020 8:12:41 AM	Che
3 Limp Mode	1/22/2020 8:12:41 AM	Che

19 Download Alarm History

6.3.7 Enabling Remote Control for Third-Party Support

The Remote Support screen allows you to set up the VARC for control by third-party technical support.

1. To display the Remote Support screen, from the Main screen, tap Remote Support. See “Touch Screen” on page 5.
2. To enable or disable remote support, tap the Enable Remote Support button. (Default is enabled.)

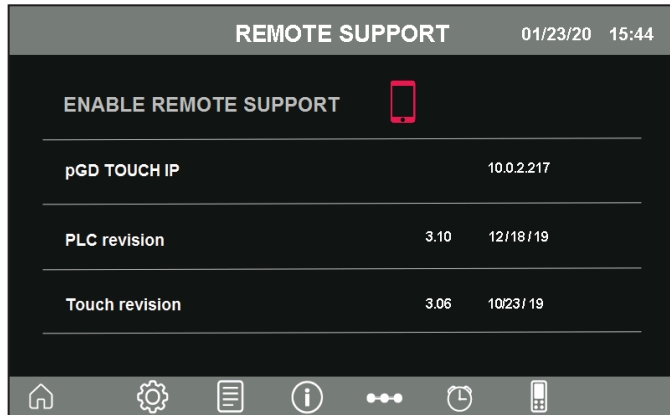

20 Enable Remote Support Screen

3. In the MobileVNC Settings dialog box, on the Control tab, press Start to begin remote login and press Stop to finish.

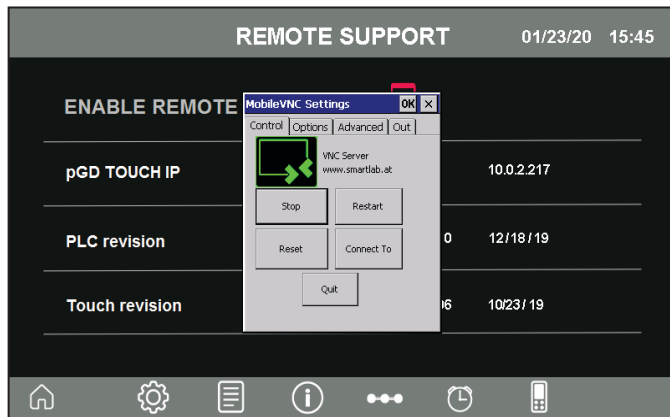

21 MobileVNC Settings Dialog Box

4. Use the settings on the Advanced tab to select configuration options for the remote login.

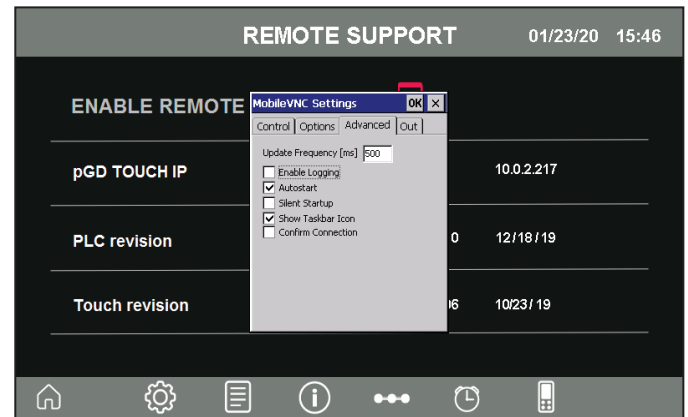

22 MobileVNC Settings Advanced Tab

6.4 Operating the LCD Screen

The following LCD instructions refer to the PGD1 display. For the PLDPRO display, use the corresponding buttons. See “PLDPRO LCD Display” on page 4.

6.4.1 Understanding the Display Screens

The Main screen allows you to monitor single-stage operation and additional stages in multi-stage operation.

The Main screen displays the following parameters:

- a. Mode of operation (Econo or Normal)
- b. Chilled water return temperature
- c. Chilled water supply temperature
- d. Condenser outlet temperature

The condenser outlet temperature is the freeze control indicator for the condensers in heat mode.



Pressing the Scroll Down button moves through the various parameters displayed on the LCD screen. In a multi-stage configuration, you can scroll through the parameters of the additional stages.



The screens following the main screen contain information for each stage.

1. The first screen displays the CW Supply and CW Return temperatures, flow switch status (FI) and high pressure status.

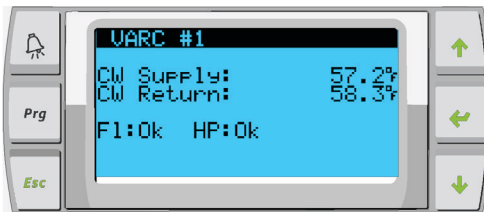

2. The next screen displays compressor speed and information to indicate if the system is in a safety count down. Once this time has elapsed and other time delays have been met, the VARC starts up.

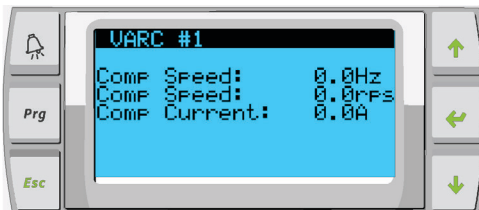

3. The next screen displays the suction pressure, the discharge pressure, the superheat value, and the sub-cooling value being calculated by the system.

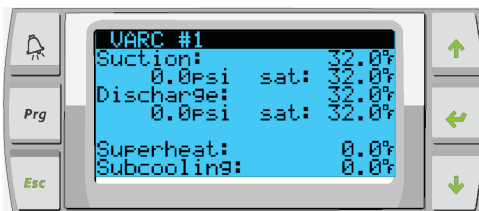

4. The following screens display the drive status. To access these screens, press Enter:

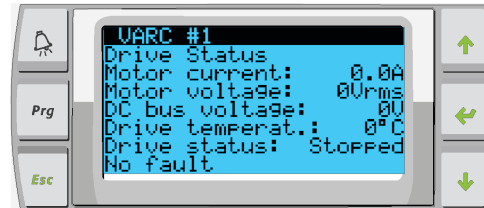
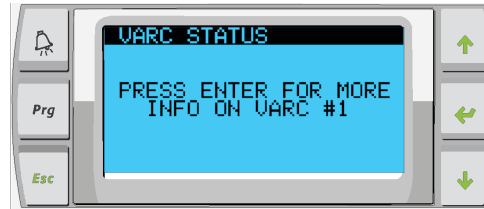

5. The final screen displays an image of the refrigerant circuit and showing the valve position.

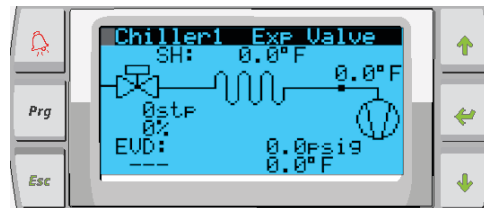

6.4.2 Adjusting Setpoints

1. Press the Program button. See “LCD Buttons” on page 5.
2. Go to Setpoints, then enter the user password (1234).

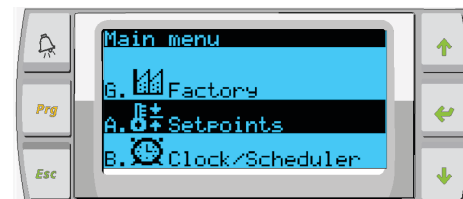

3. Press Enter once to update the Heating setpoint, by pressing the Scroll Up or Scroll Down buttons to change the value. Press Enter again to change the cooling setpoint.

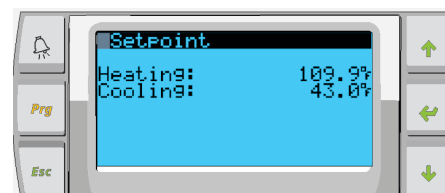

6.4.3 Enabling Electric Heat

1. Press the Program button. See “LCD Buttons” on page 5.

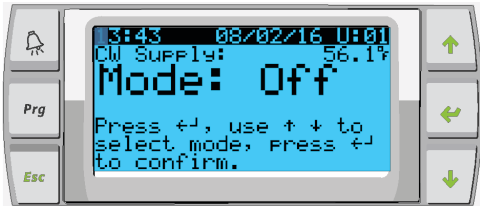

2. Scroll down to Technician, then press enter.

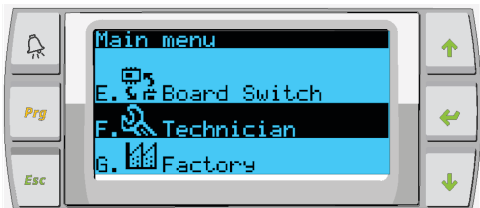

3. Scroll down to Service settings, then press Enter.

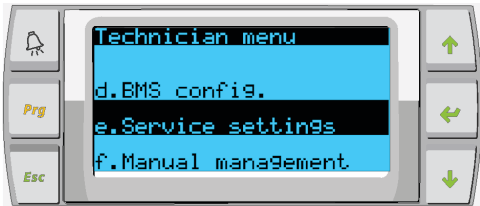

4. Enter the service password 3156.



5. Scroll down to System Setup, then press enter.

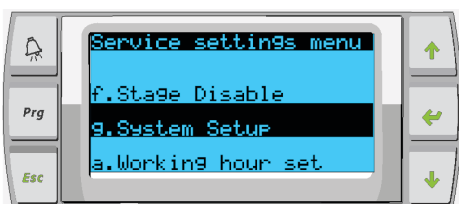

6. Scroll down to Electric Heat, press Enter to select, and then press the Scroll Up or Scroll Down buttons to toggle the setting.

7. Press Enter to save.



6.4.4 Setting Time and Date

1. Press the Program button. See “LCD Buttons” on page 5.

2. Scroll to Clock/Scheduler, then press Enter.

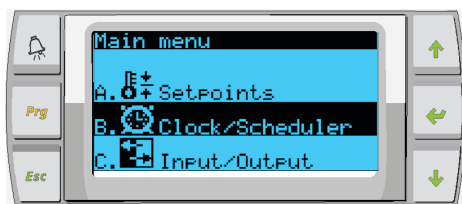

3. Press Enter.

The cursor flashes on the date field: mm/dd/yyyy.

4. Use the Scroll Up and Scroll Down buttons to select the correct month. Press Enter, then press the Scroll Up and Scroll Down buttons to select the correct day.

5. Press Enter, then use the Scroll Up and Scroll Down buttons to select the year.

6. Press Enter.

a. The cursor drops down to the Hour field.

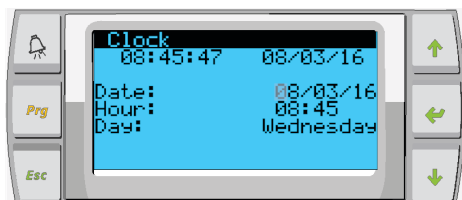

- Use the Scroll Up and Scroll Down buttons to select the correct hour, then select the minute.

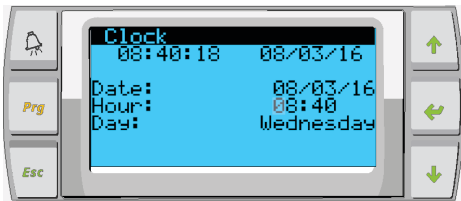

- The cursor goes back to the Clock title. Settings have been saved and you can exit to Main screen.
- Daylight Savings Time is enabled by default. If you wish to disable, scroll down from the Clock screen.

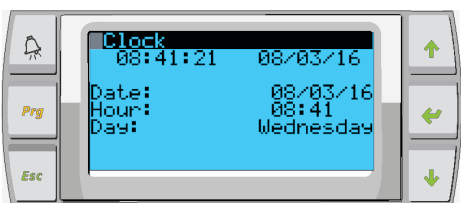

6.4.5 Changing Temperature Display Units

- Press the Program button. See “LCD Buttons” on page 5.
- Go to Setpoints, then enter the password (3156).

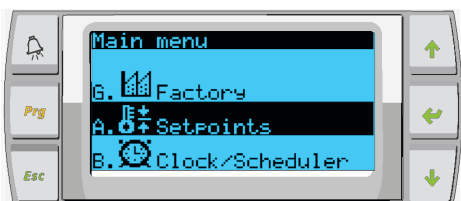

- Scroll down to the Temperature Units screen. Press Enter to select. Use the Scroll Up and Scroll Down buttons to toggle between options.

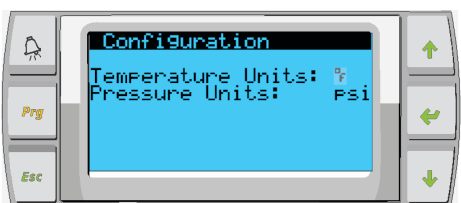

- After selecting the desired option, press Enter to return the cursor to the top of the screen.
- Make this change to all stages so that it correctly reflects temperature readings on the remote display.

6.4.6 Viewing Alarms for Each Stage

The Main screen indicates alarms by flashing the word Alarm in the lower-right corner.

i The PLDPRO display sounds a tone as well as displaying the word Alarm in the lower-right corner.

The Alarm screen captures a snapshot of the system parameters at the time of the fault.

The alarm history captures and displays the following parameters:

- Compressor speed
 - Chilled water return
 - Chilled water supply
 - Discharge pressure
 - Suction pressure
- To view the alarm information for more than one stage, you need to switch boards via the display or look at the PLDPRO display for that stage.

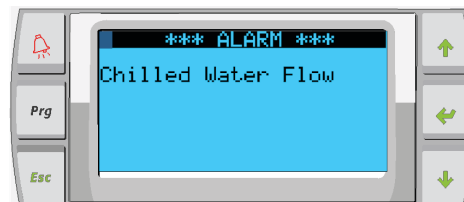

- Use the alarm logger to view the alarm history.

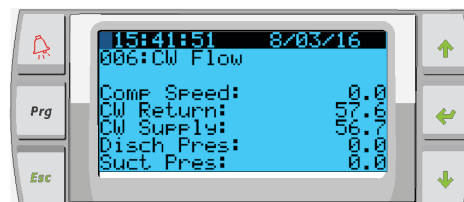

- To clear an alarm when a fault has been corrected, press and hold the Alarm button for five seconds to clear the active alarm.

6.4.7 LCD Screen Menu Maps

The following diagrams show the menu options for each screen available through the LCD displays.

The Main screen is displayed at powerup. It displays the essential system information.

i An asterisk (*) indicates an option that is available only when activated in the factory settings.

Main Status Screen	
CW Supply Temp	##.#°F
Mode	Off/Cool/Heat/ EI Ht*
CW Return temp	##.#°F
CW Supply temp	##.#°F
Cond. Outlet temp	##.#°F
Mode	Off/Cool/Heat/ EI Ht*
Pumps	
CW	On/Off
SW	On/Off
Chiller Status	Normal/Econo
Maint Mode Active	
Stage #	Auto/Disabled
Varc #1	
CW supply temp	##.#°F
CW return temp	##.#°F
Flow status	Ok/Alm/Off
High pressure status	Ok/Alm/Off
Electric Heat*	Ok/Alm/Off
EH FL*	Ok/Alm/Off
Compressor speed	##.# Hz
Compressor speed	##.# rps
Compressor Current	##.# A
Suction	
Temperature	##.#°F
Pressure	##.# psi
Saturation Temp.	##.#°F
Discharge	
Temperature	##.#°F
Pressure	##.# psi
Saturation Temp.	##.#°F
Super heat temp	##.#°F
Subcooling temp	##.#°F
VARC #* (if multistage)	
Varc #1 information	

Varc # 1 Information	
Compressor Capacity Regulator	
Required Capacity	%
Actual Capacity	%
Actual Speed	rps
Drive Status	
Motor Current	##.# A
Motor Voltage	# Vrms
DC Bus Voltage	### V
Drive Temperature	## °F
Drive Status	Stopped/Running
Fault	
Flow Diagram	
Super Heat	## °F
Compressor	## °F
EEV Open %	## %
EEV Open Stps	### stp
EEV	### psi
Std-by temp	## °F

23 Main Screen

The Program menu provides access to user settings, the Factory screen, and the Technician screen.

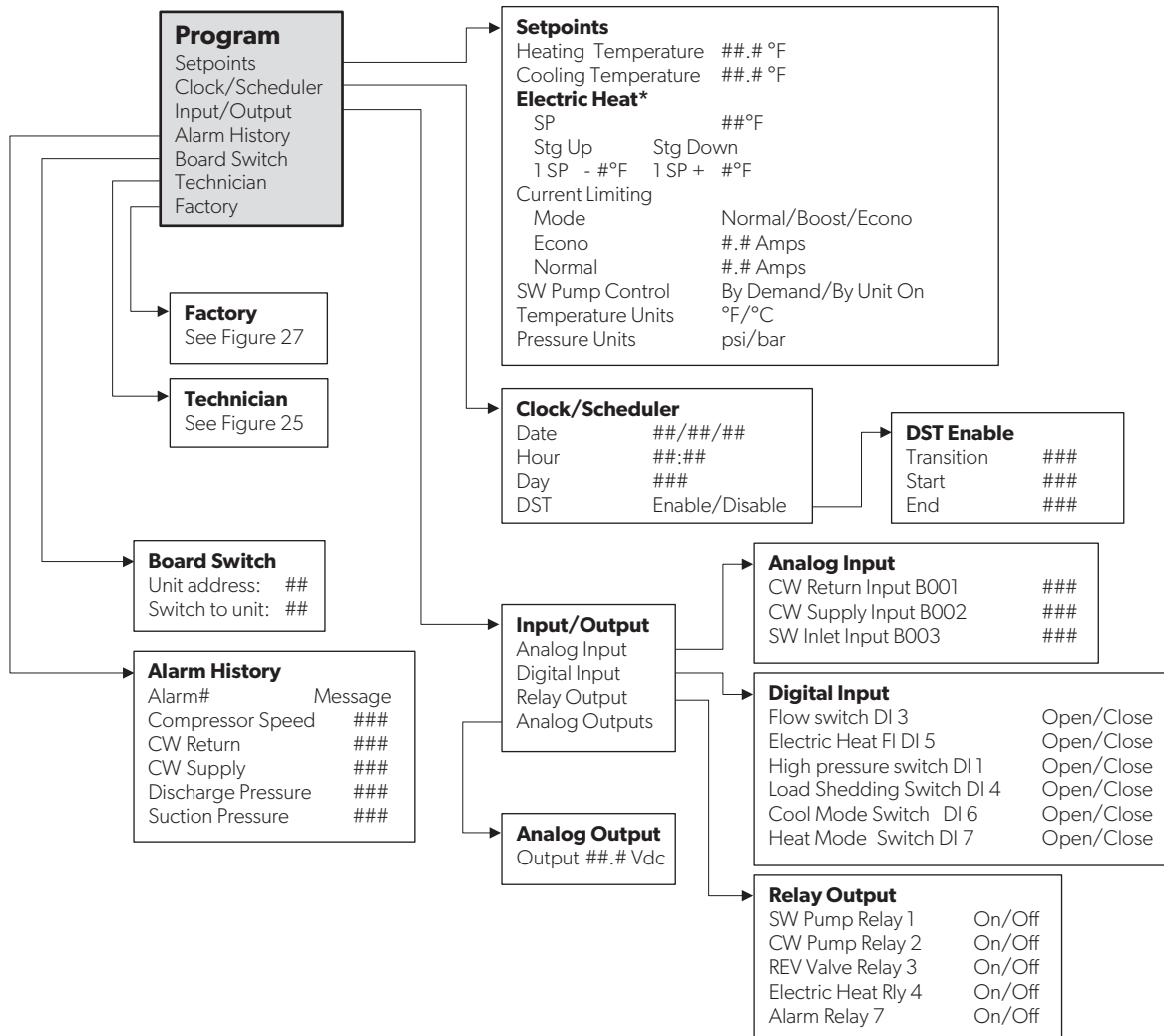

24 Program

The Technician menu requires the technician password (3156).

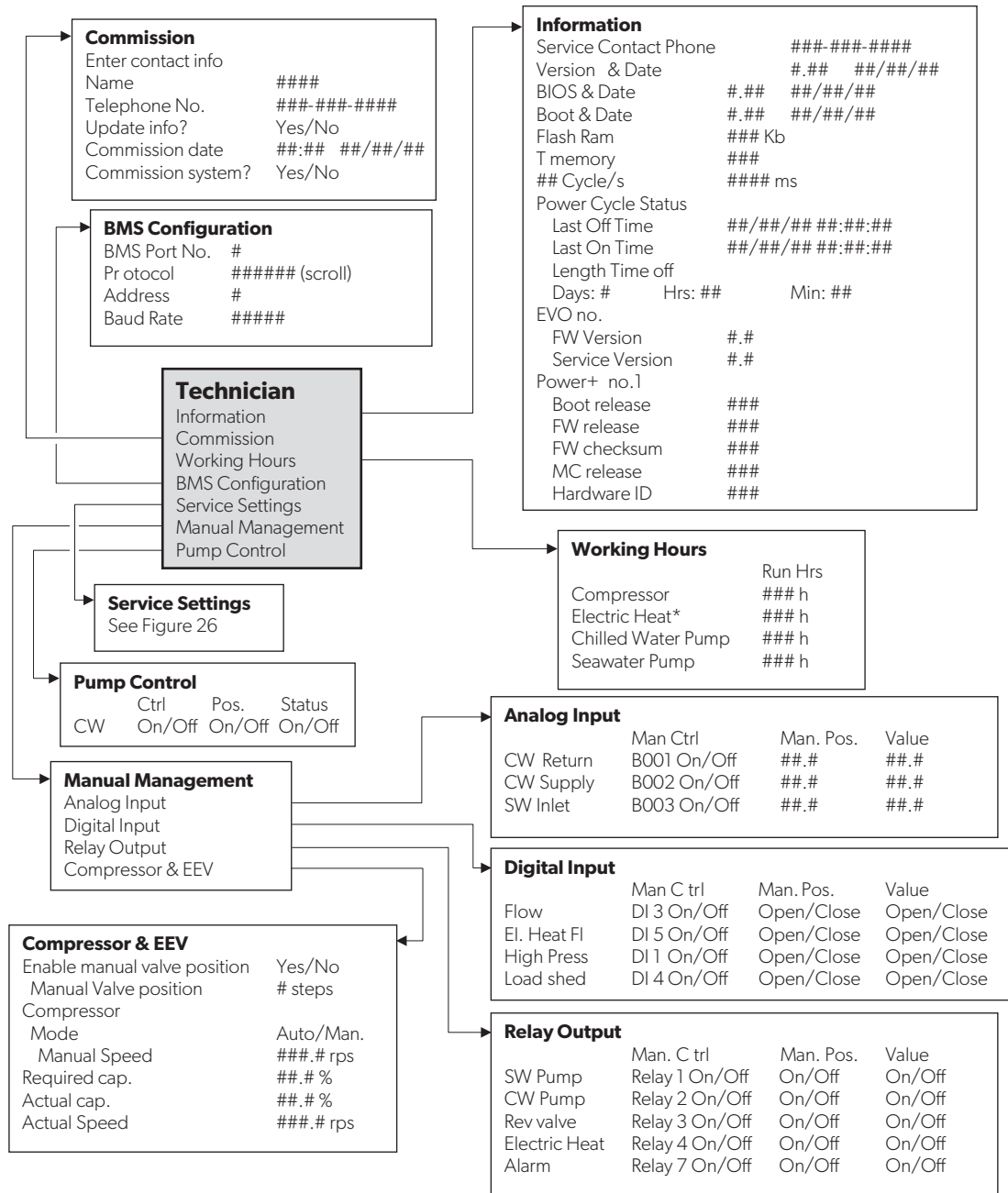

25 Program/Technician

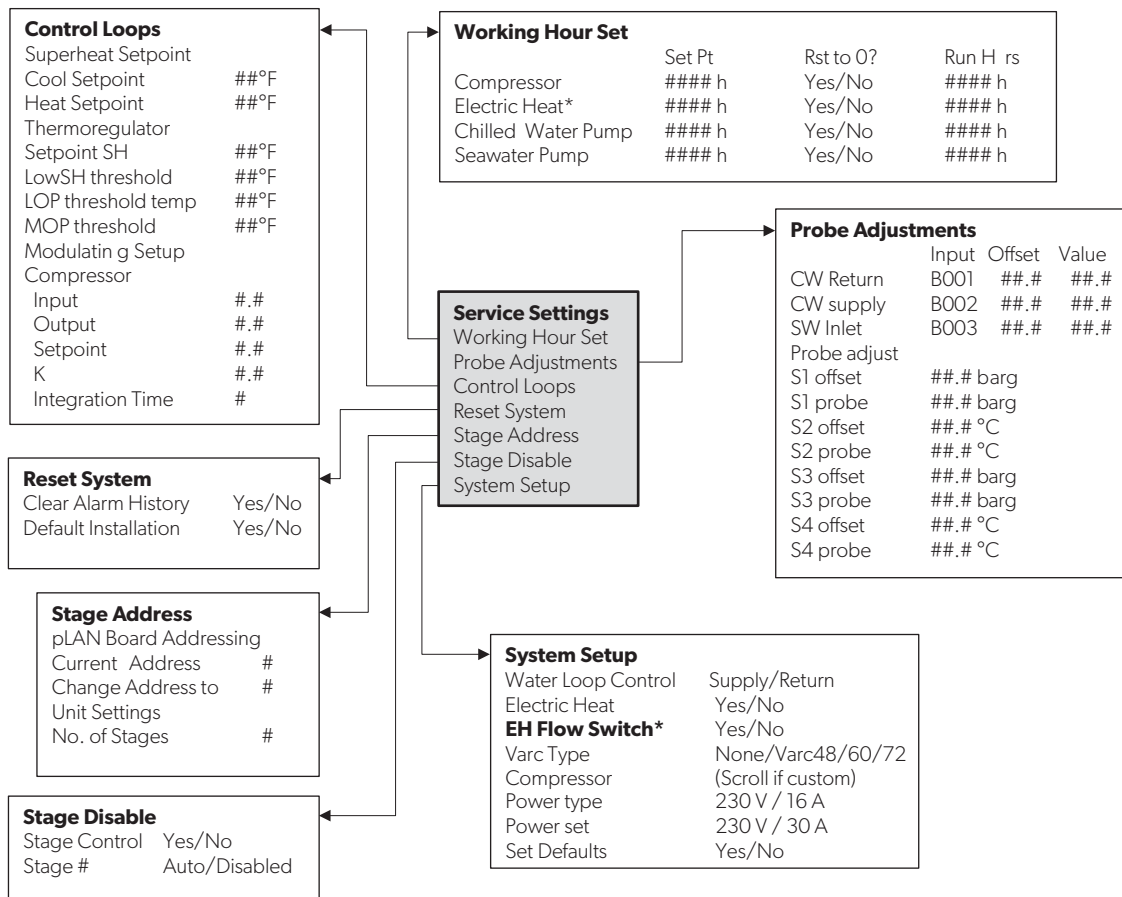

26 Program/Technician/Service Settings

The Factory menu requires the factory password, which is available only to authorized Dometic personnel.

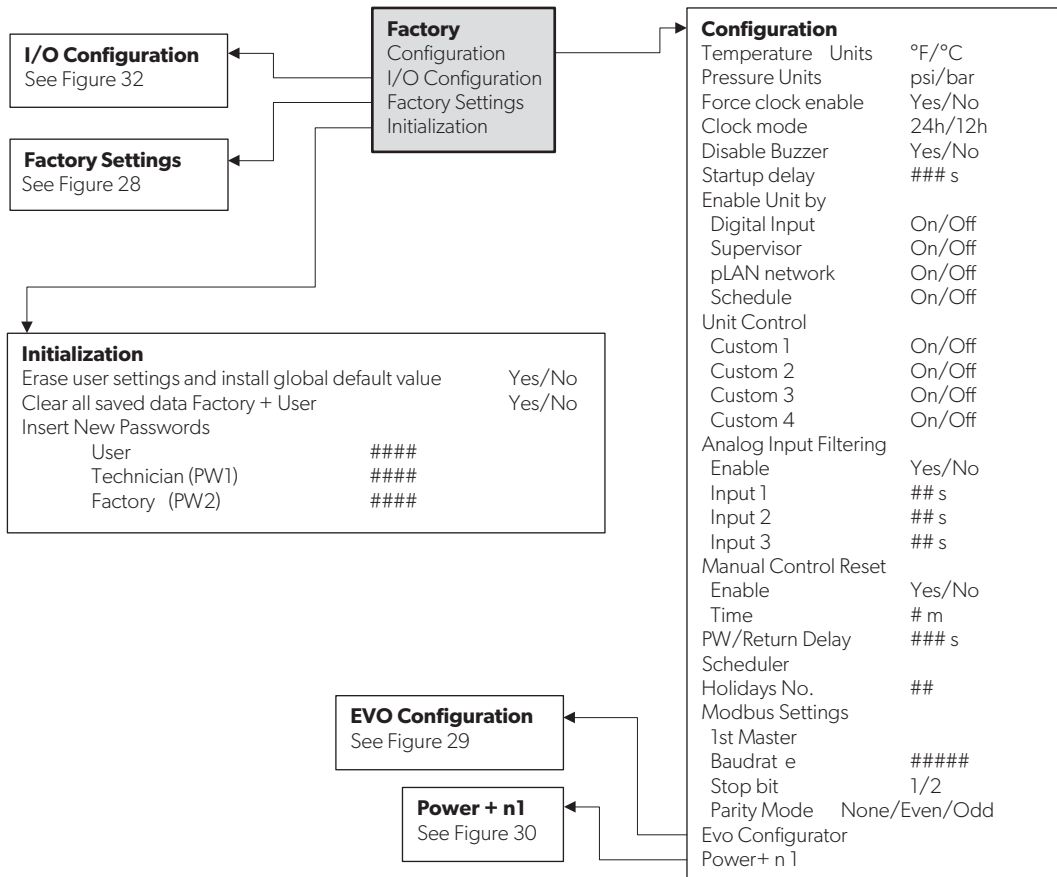

27 Program/Factory

In the following diagram, the dotted boxes indicate a breakout of the additional information that is contained below that menu category.

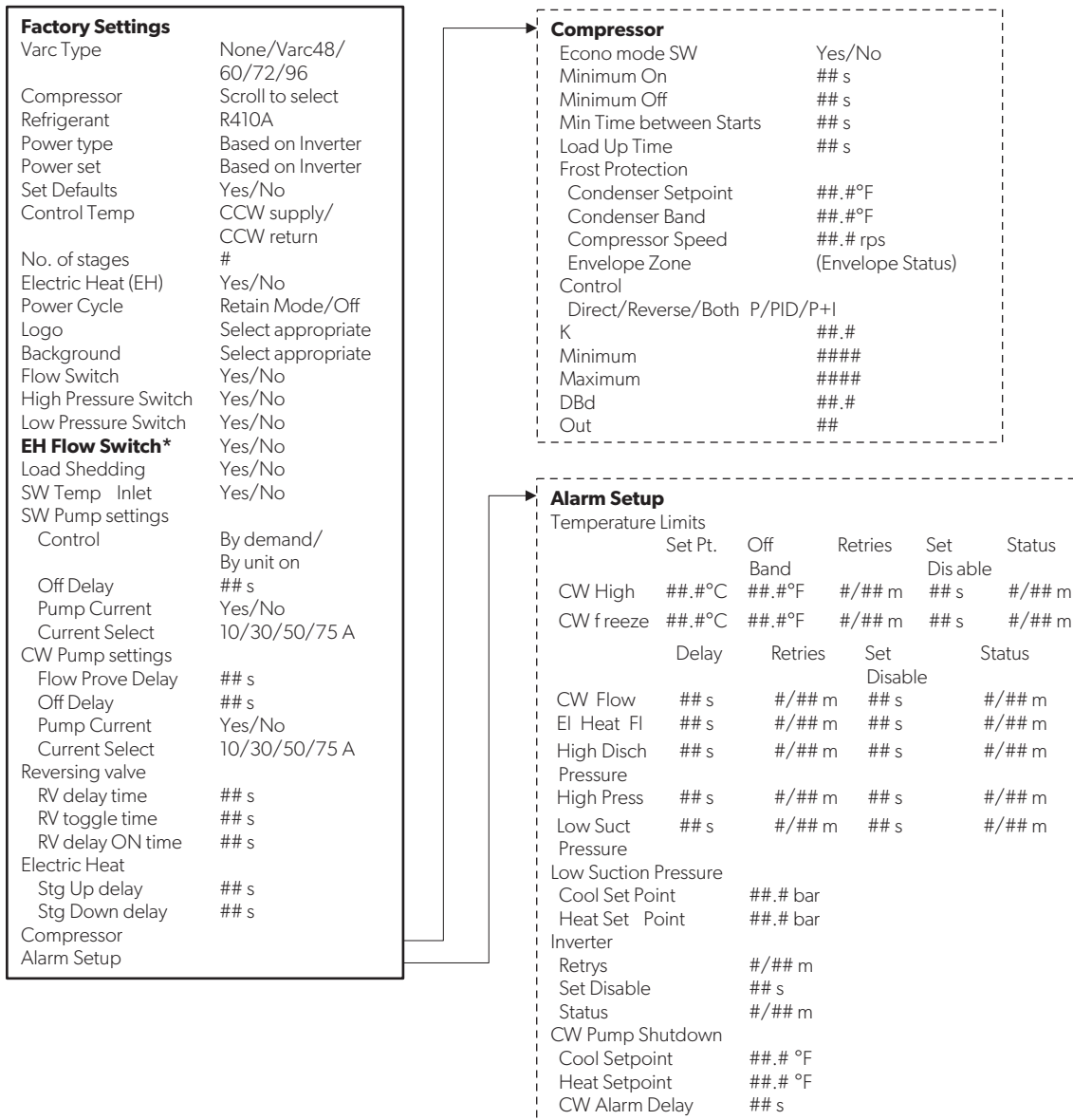

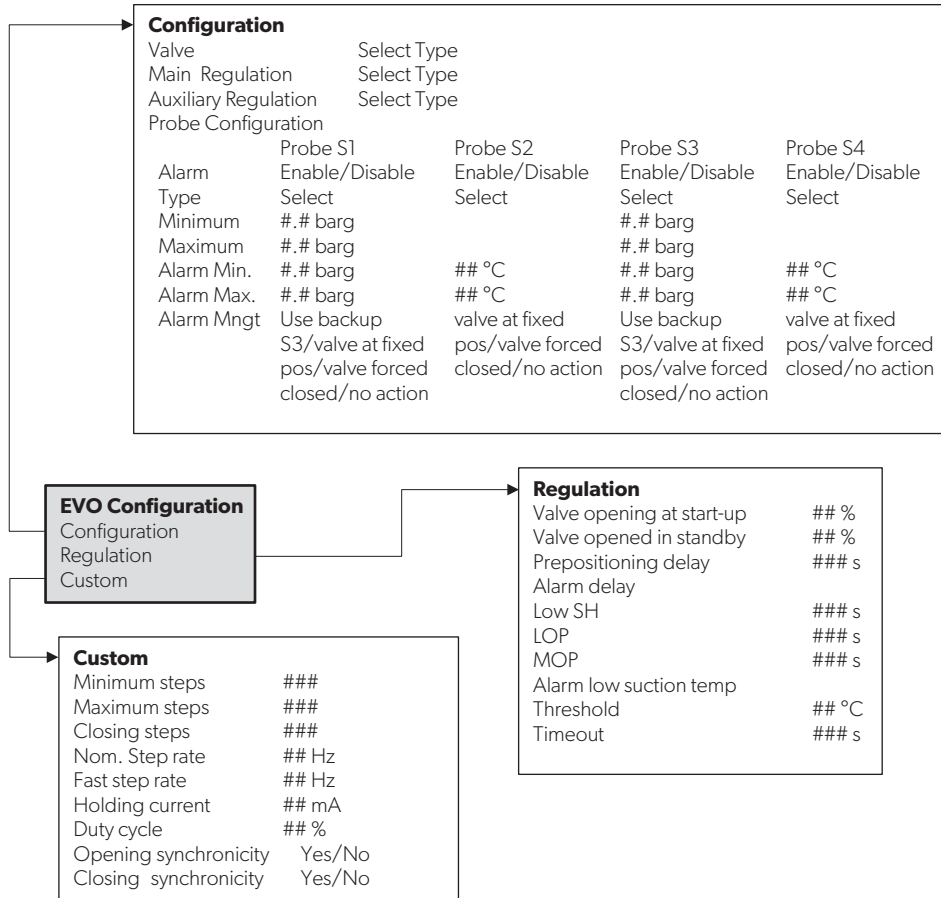

29 Program/Factory/Configuration/EVO Configuration

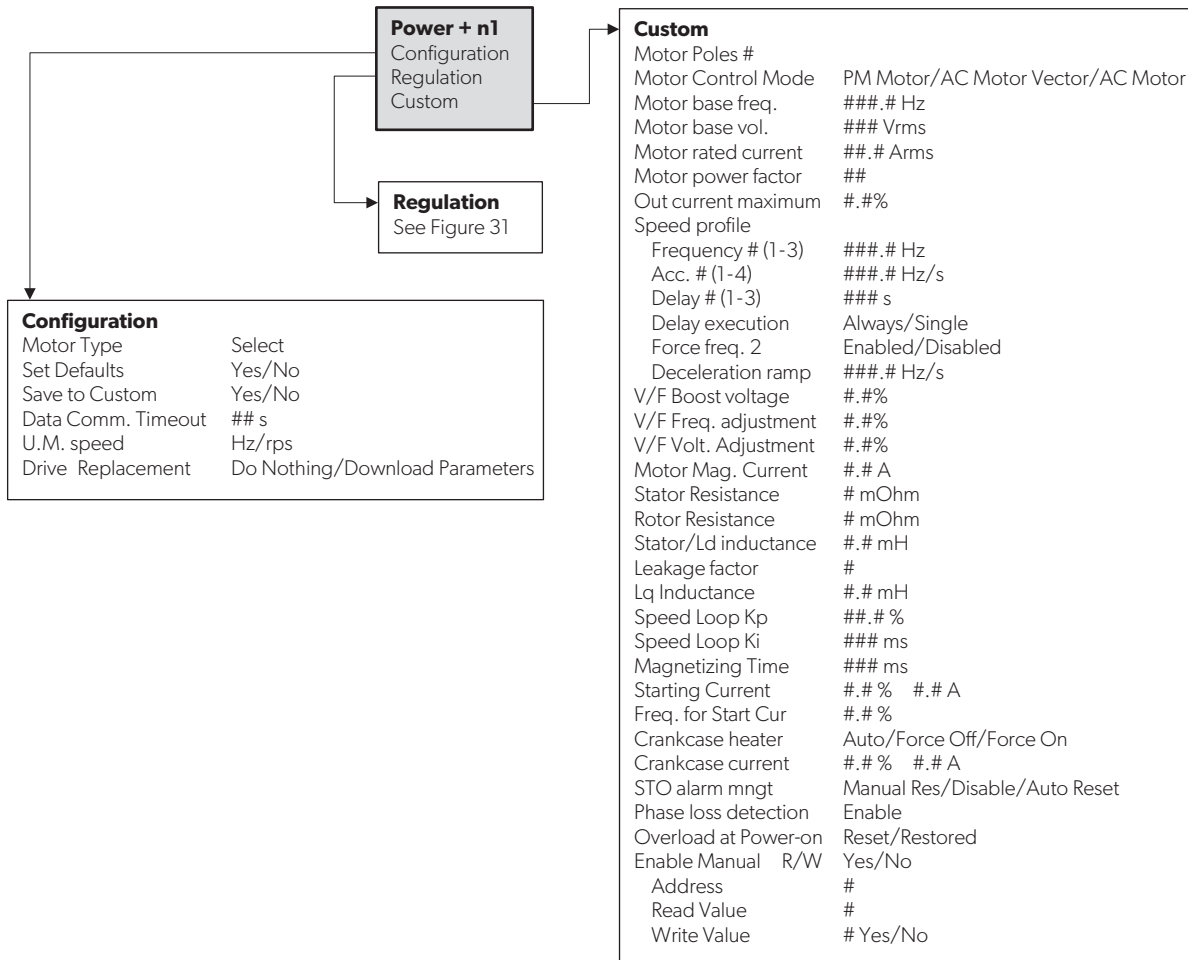

30 Program/Factory/Configuration/Power + n1

In the following diagram, the dotted boxes indicate a breakout of the additional information that is contained below that menu category.

i An asterisk (*) indicates an option that is available only when activated in the factory settings.

Regulation		
Output frequency min	#.# Hz	
Output frequency max	#.# Hz	
Skip frequency set #(1-3)	#.# Hz	
Skip frequency band #(1-3)	#.# Hz	
Switching frequency	# kHz	
Switching frequency derating	Disabled/Enabled	
Speed derating mode	##	
Stop mode	Ramp/Coast	
Reverse Speed	Disabled/Enabled	
Flying Start	Disabled/Enabled	
Relay Configuration	Select	
PTC Alarm	Disabled/Enabled	
PTC Alarm delay	## s	
Compressor Regulator		
Start -up pressure differential control		
Max pressure diff. admitted	#.# bar	
Equalization mode	Equalztn valve/EEV Pre-Opening	
Start -up failure control		
Pressure diff. min. variation	#.# bar	
Control period	## s	
Restart delay	## s	
Max Retry #	#	
Speed Management		
Start -up forced speed	##.# rps	
Max speed	##.# rps	
Min speed	##.# rps	
Deceleration rate	#.# rps/s	
Acceleration rate	#.# rps/s	
Switch -off rate	#.# rps/s	
Envelope Control		
Speed reduction rate	#.# rps/s	
Min speed admitted	#.# rps	
Out of env. Alarm timeout	## s	
Low press. diff. alarm timeout	## s	
Discharge Gas Control High Discharge Temp.		
Limit	##.# °C	
Alarm	##.# °C	
Speed Control due to Discharge Gas		
Action Distance	##.# °C	
Action Pause	## s	
Comp. Speed Reduction	#.# %	
EEV Regulation		
Mode	Select from EEV Mode List	
Discharge Temp Probe Comp Time	##.# s	
Discharge	Super Heat Temperature	
Setpoint	##.# °C ##.# °C	
Offset	##.# °C ##.# °C	
Hystere sis	##.# °C ##.# °C	
Envelope Control - Low ratio management		
By EEV closing	Yes/No	
By compressor speed	Yes/No	

EEV Pre-Opening*	
Max. Equalization	## s
EEV opening	##.# %

EEV Mode List	
Suction Superheat	
Discharge Temperature	
Discharge Superheat	

31 Program/Factory/Configuration/Power + n1 /Regulation

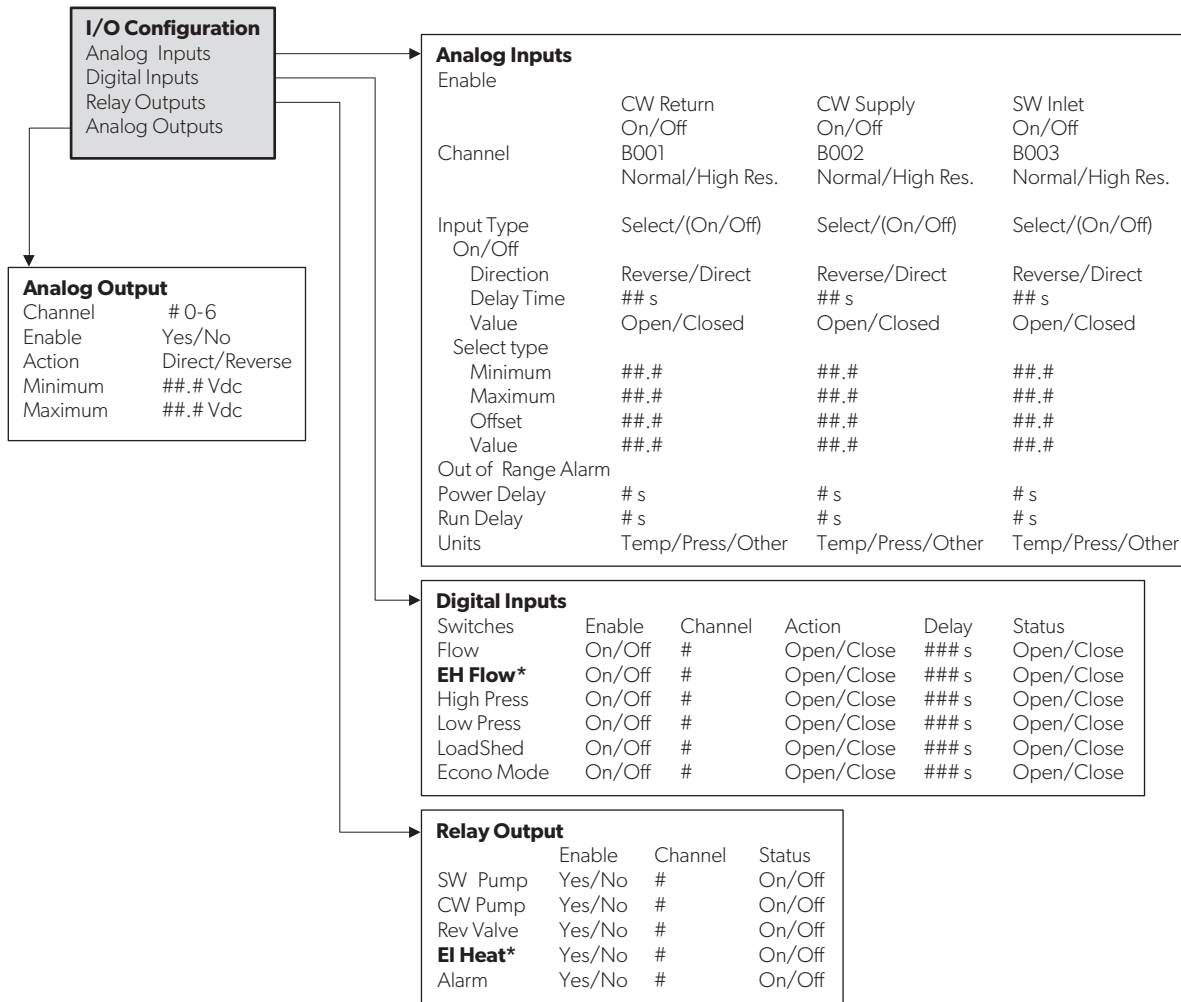

32 Program/Factory/IO Configurations

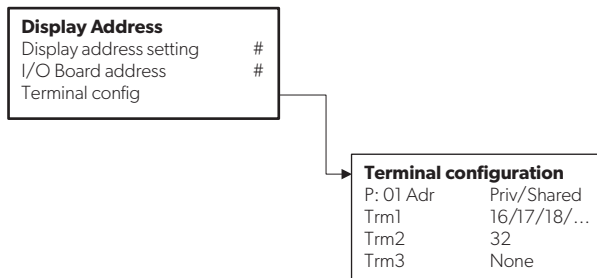

33 Display Address

7 Maintenance Mode

In Maintenance mode you can disable any of the stages in the system. This allows for ease of troubleshooting and maintenance on one unit, while maintaining full functionality for the other stages.

⚠ WARNING: ELECTRICAL SHOCK HAZARD.

Maintenance and repair should be performed only by qualified technicians. Failure to obey this warning could result in death or serious injury.

7.1 Accessing Maintenance Mode from the LCD Screen

1. In the Main screen, press Enter and scroll up or down to select OFF, then press Enter to save.

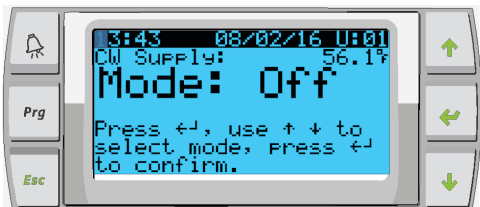

2. To access the Maintenance mode menu, press Program, scroll to Technician, and then press Enter.



3. Scroll to service settings, then press Enter.

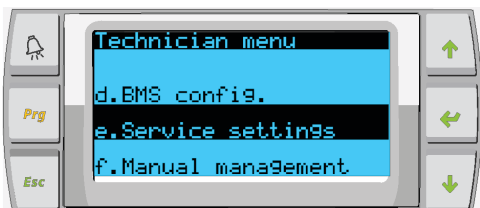

4. Enter the service password: 3156.



5. Scroll to Stage Disable, then press Enter.

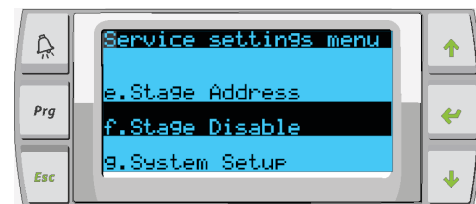

6. For Stage Control, change No to Yes, press Enter, scroll up, and then press Enter.

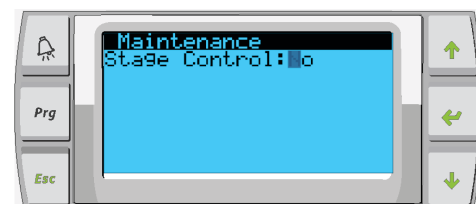

The screen displays the stages.

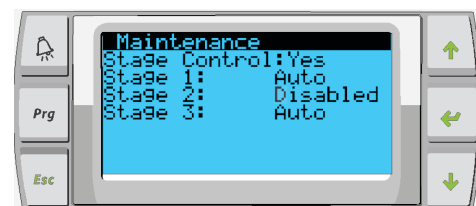

7. Press Enter to access each stage, then scroll up or down to change from Auto to Disabled.

7.2 Accessing Maintenance Mode from the Touch Screen

1. Tap the touch screen to view the menu buttons, then tap Chiller Summary. See "Touch Screen" on page 5.

i The system must be in off mode to access maintenance mode.

2. Tap the wrench icon.

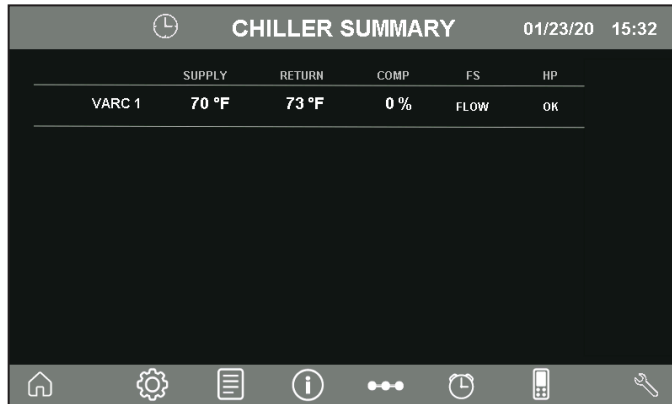

34 Chiller Summary

3. From the Chiller Control menu, select YES to enable Maintenance mode.

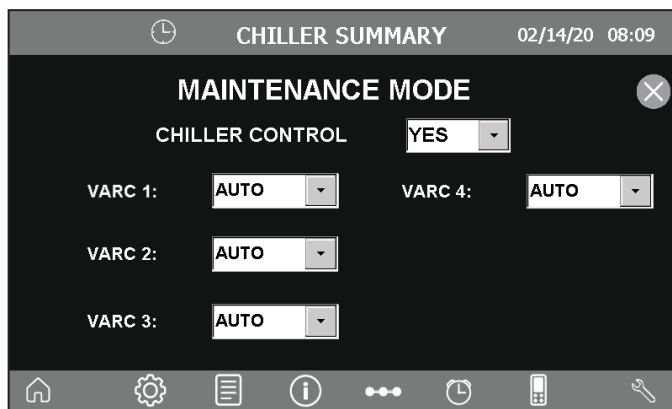

35 Chiller Control Menu

4. To disable a stage, tap the menu to the right of the stage number and select Disabled.

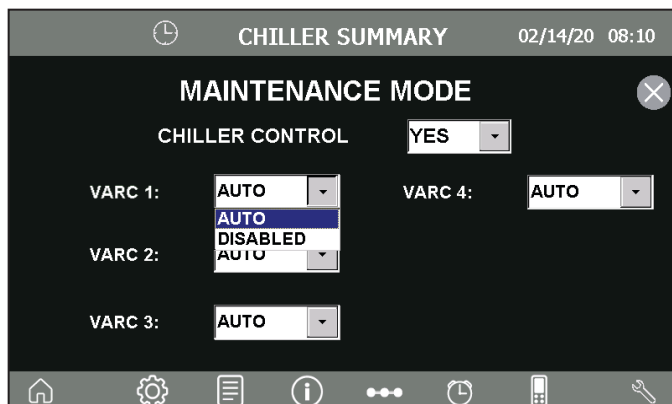

36 Disable Stage

5. Tap X to exit, then turn on the VARC.

8 Troubleshooting

The following tables describe the VARC alarm characteristics and corrective actions.

⚠ WARNING: ELECTRICAL SHOCK HAZARD. Failure to obey the following warnings could result in death or serious injury:

- Exercise extreme care when working around energized equipment.
- Maintenance and repair should be performed only by qualified technicians.

8.1 Alarms

In the event of a fault, the system does not generate an alarm immediately, but instead applies an alarm retry logic scheme. The system shuts down and attempts the number of retries that is set on the parameters table before creating an alarm that needs to be reset manually.

The following table describes the alarm conditions and corrective actions to be taken.

Alarm	Reset	Delay	Alarm Relay	System Action	Corrective Actions
Alarms Power+ n°1 None 1:Overcurrent 2:Motor Overload 3:Overvoltage 4:Undervoltage 5:Over Temp 6:Under Temp 7:Overcurrent HW 8:Motor Overtemp 9:Drive Failure 10:CPU Error 11:Param Default 12:DC bus ripple 13>Data Comms Fault 14:Drive thermistor 15:Autotune fault 16:Drive disabled 17:Motor Phase 18:Fan Fault 19:Speed Fault 20:PFC Failure 21:Overvoltage 22:Undervoltage 23:STO Detection 24:Reserved 25:Ground Fault 26:CPU Sync 1 27:CPU Sync 2 28:Drive overload 29:Reserved ... 99:Unexpected inverter stop	Manual	Immediate	Yes	Turns off compressor	<ul style="list-style-type: none"> • Check the load. • Check the network control devices and cables. • Check the input voltage. • Using a 1000 V megohmmeter, check the motor and motor cables for ground faults. • Check the input and output circuits for phase loss detection. • Check the condition of the motor and load wiring.
Chilled Water Flow	After three retries every 30 minutes, must be reset manually	Immediate	Yes	Turns off compressor or heat relay	<ul style="list-style-type: none"> • Check for proper loop water flow and make sure the strainers are not clogged. • Check for a defective flow switch. • Bleed air out of the loop water. • Check the loop water pump.
Chilled Water Return Sensor Failure	Manual	Immediate	Yes	Turns off VARC	<ul style="list-style-type: none"> • Check the sensor for shorts and opens. • Compare the temperature reading with the digital thermometer.
Chilled Water Supply High	Manual	10 sec	Yes	Turns off compressor or heat relay	Check for low water flow due to restrictions or pump wear.
Chilled Water Supply Low	Manual	10 sec	Yes	Turns off compressor or heat relay	Check for low water flow due to restrictions or pump wear.

Alarm	Reset	Delay	Alarm Relay	System Action	Corrective Actions
Chilled Water Supply Sensor Failure	Manual	Immediate	Yes	Turns off VARC	<ul style="list-style-type: none"> Check the sensor for shorts and opens. Compare the temperature reading with the digital thermometer.
Clock Board Fault or Not Connected	Automatic	Immediate	Yes	Warning signal	
Compressor Start Failure	After 5 times in 60 minutes, must be reset manually	10 sec		Warning signal	<ul style="list-style-type: none"> Compare the voltage to the compressor. Check the power inverter.
Condenser Out Temperature Sensor Failure	Manual	Immediate		Warning signal	<ul style="list-style-type: none"> Check the sensor for shorts and opens. Compare the temperature reading with the digital thermometer.
Electric Heat Run Hours Exceeded			Yes	Turns off heater	Check heater the voltage.
Envelope Alarm	Manual	60 sec	Yes	Turns off compressor	
EVD Evo High Evaporation Temperature (MOP)	Automatic	Immediate	Yes	Warning signal	Check the refrigerant charge.
EVD Evo Low Evaporation Temperature (LOP)	Automatic	Immediate	Yes	Warning signal	<ul style="list-style-type: none"> Check the water flows. Check the refrigerant charge.
EVD Evo Low Suction Temperature	Automatic	Immediate	Yes	Warning signal	Check the refrigerant charge.
EVD EVO Low Superheat	Automatic	Immediate	Yes	Warning signal	<ul style="list-style-type: none"> Check for proper refrigerant charge as the system may be overcharged. Check the water for low flow. Check the EEV movement and functionality.
EVD Evo Probes fault or disconnected (S1, S2, S3, S4)	Automatic	Immediate	Yes	Turns off compressor	Check the condition of the wiring and connections.
Frost Active	Manual	Immediate	Yes	Slows down compressor	<ul style="list-style-type: none"> Low temperature temp switch tripped. Check the water flows. Check r the refrigerant charge.
High Discharge Gas Temperature	Automatic	30 sec		Warning signal	Check for the proper refrigerant pressure with the gauge.

Alarm	Reset	Delay	Alarm Relay	System Action	Corrective Actions
High Discharge Pressure	After 3 retries every 30 mins, must be reset manually	Immediate	Yes	Turns off VARC	<ul style="list-style-type: none"> • Check for the proper refrigerant pressure with the gauge. If normal, check for a defective pressure switch. • Check that there is proper sea water and loop water flow. • Check that water strainers are not clogged. • Check that the system is not overcharged.
Inverter Model Not Compatible	After 15 retries every 60 mins, must be reset manually				Make sure Power+ is being used.
Low Pressure Differential	Manual	90 sec	Yes	Turns off VARC	<ul style="list-style-type: none"> • Check the EEV motor. • Use a gauge to check for proper the refrigerant pressure. • Check suction the temperature to verify that the reversing valve is in proper position.
Low Suction Pressure	After 3 retries every 30 mins, must be reset Manually	60 sec	Yes	Turns off VARC	<ul style="list-style-type: none"> • Use a gauge to check for the proper refrigerant pressure. If normal, check for a defective pressure switch. • Check for the proper sea water and loop water flow • Check that the water strainers are not clogged. • Check that the system is not undercharged.
Power+ Device Offline	Automatic	30 sec	Yes	Turns off compressor	
Power+ in Retry				Warning signal	Check the power supply.
Sea Water Inlet Low	Manual	10 sec	Yes	Warning signal	Low temperature due to geographical climate.
Sea Water Inlet Sensor Failure	Manual	Immediate	Yes	Warning signal	<ul style="list-style-type: none"> • Check the sensor for shorts and opens • Compare the temperature reading with the digital thermometer.

8.2 Envelope Zone Status Descriptions

Refer to the following table for envelope alarms. The alarm shows the zone number and the description provides details.

Zone	Name	Description
1	Inside envelope zone	Working point inside limits
2	High compression ratio	Low gas density -> maximum discharge temperature
3	High condensing pressure	Mechanical limit
4	Maximum motor current	High gas density-> maximum torque
5	High evaporating pressure	High gas density-> mechanical limit, noise
6	Low compression ratio	Loss of contact between spirals, vibrations
7	Low pressure difference	Loss of lubrication
8	Low condensing pressure	Low oil temperature -> high viscosity -> poor lubrication
9	Low evaporating pressure	Low gas density -> low motor cooling

9 Disposal



Place the packaging material in the appropriate recycling waste bins, whenever possible. Consult a local recycling center or specialist dealer for details about how to dispose of the product in accordance with all applicable national and local regulations.

10 Warranty Information

LIMITED WARRANTY AVAILABLE AT
WWW.DOMETIC.COM/WARRANTY.

IF YOU HAVE QUESTIONS, OR TO OBTAIN A COPY OF THE LIMITED WARRANTY FREE OF CHARGE, CONTACT:

DOMETIC CORPORATION
 MARINE CUSTOMER SUPPORT CENTER
 2000 NORTH ANDREWS AVENUE
 POMPANO BEACH, FLORIDA, USA 33069
 1-800-542-2477

Mobile living made easy.



dometic.com

**YOUR LOCAL
DEALER**

dometic.com/dealer

**YOUR LOCAL
SUPPORT**

dometic.com/contact

**YOUR LOCAL
SALES OFFICE**

dometic.com/sales-offices

A complete list of Dometic companies, which comprise the Dometic Group, can be found in the public filings of:
DOMETIC GROUP AB Hemvärnsgatan 15 SE-17154 Solna Sweden